

Federal Democratic Republic of Ethiopia  
Ministry of Health

# Onsite Household Latrine Technology Option Planning and Construction Manual



Federal Ministry  
of Health



Addis Ababa, Ethiopia  
May 2017





Federal Democratic Republic of Ethiopia  
**Ministry of Health**

# Onsite Household Latrine Technology Option Planning and Construction Manual

Addis Ababa, Ethiopia  
May 2017

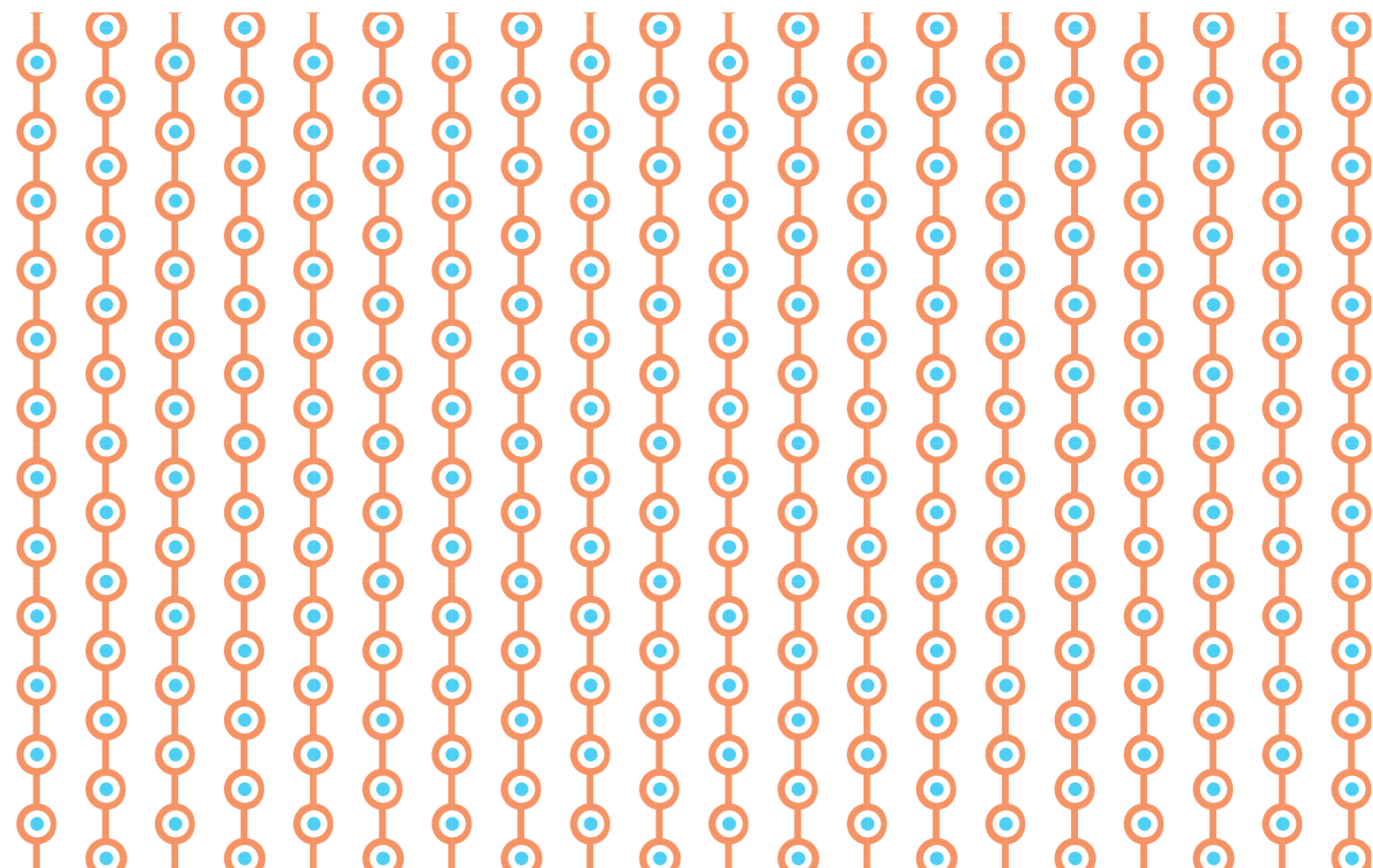



## Acknowledgements

The Federal Ministry of Health (FMoH) would like to extend its gratitude to World Bank Water Global Practice (WB/WGP) Ethiopia Country Office for their financial and technical support on preparation of the On-site Household Latrine technology Option Planning and Construction manual. The FMoH acknowledges Mr. Yared Legesse, WASH Specialist, World Bank Consultant, for his full engagement in the development of this manual. Special thanks also goes to Mr. Oliver Jones, Senior Water and Sanitation Specialist, World Bank, for his guidance throughout the development process of the manual.

Finally, the FMoH extends its gratitude to the following members of the technical working group and professionals from WASH sector organizations who have reviewed the draft manual and contributed to enrich the manual.

<b>Mr. Dagnew Tadesse</b>	(MoH, Hygiene and Environmental Health Case Team)
<b>Mr. Sileshi Taye</b>	(MoH, Hygiene and Environmental Health Case Team)
<b>Mr. Abreham Misganaw</b>	(MoH, Hygiene and Environmental Health Case Team)
<b>Mr. Wondayehu Wube</b>	(MoH, Hygiene and Environmental Health Case Team)
<b>Mr. Yared Tadesse</b>	(MoH, Hygiene and Environmental Health Case Team)
<b>Mr. Mesele Manaye</b>	(MoH, Hygiene and Environmental Health Case Team)
<b>Mr. Dereje Mengistu</b>	(MoH, Hygiene and Environmental Health Case Team)
<b>Mr. Chanyalew Tadesse</b>	(MoH, Hygiene and Environmental Health Case Team)
<b>Mr. Abate Benti</b>	(MoH, Hygiene and Environmental Health Case Team)
<b>Mr. Sirak Wondimu</b>	(WB/WGP, Sanitation BD and Marketing Specialist)
<b>Mrs. Addis Meleskachew</b>	(WB/WGP, Sanitation BD and Marketing Specialist)
<b>Mr. Abdulkadir Memhur</b>	(WB/WGP, WASH Specialist, Consultant)
<b>Mr. Arito Sumen</b>	(COWASH, Member of the SM TWG)
<b>Mrs. Netsanet Kasa</b>	(UNICEF, Ethiopia Country Office, Member of the SM TWG)
<b>Mrs. Yeshewahareg Feyisa</b>	(CRS Ethiopia Country Office, Member of the SM TWG)
<b>Mr. Getachew Belayneh</b>	(SNV, Ethiopia Country Office, Member of the SM TWG)
<b>Mr. Abatneh Bizen</b>	(Caritas, Ethiopia Country Office, Member of the SM TWG)



## Foreword

Sanitation is an indispensable element of everybody's life; hence its availability improves overall health status of the community and determines individual ability to lead productive life. Every citizen has the right to live in a safe environment and it is each citizen's individual and collective responsibility to protect environment from faecal contamination by using safe latrine facility.

The FMoH is keen to translate the constitutional right of citizens in to practice and developed policy, programs and strategies that mitigate faecal contamination of the environment. Hygiene and environmental health program is core element of the integrated primary health care services and is being implementing through household and community based approaches. The government also created conducive environment for WASH sector engagement and with the concerted efforts of the government and sector stakeholders promising achievement has been documented to increase household's access to basic sanitation facilities.

In spite of high coverage, Ethiopia is off track to achieve MDG sanitation targets and access to improved sanitation facility is as low as 28% in rural areas. On the other hand, sanitation and hygiene related communicable diseases remain a top public health challenge, which indicate there is a need for improvement of the quality of sanitation hygiene services and sustainable change in hygiene practices. Improvement in sanitation services can only made possible by supporting households move up to the next sanitation ladder through sanitation marketing approach and sustainable behavioral change communication.

The FMoH is taking forward promotion of improved sanitation. It is being implementing sanitation marketing strategies and completed development hygiene and environmental Health behavioral communication guidelines and currently prepared complementary manual for planning and construction of on-site household latrine technology option.

Thus the purpose of this manual is to provide step by step guidance to make informed choice of affordable latrine technology by the household that is appropriate to local soil formation. The manual also serve the entrepreneurs to produce sanitation products, provide services and stakeholders who are engaged in hygiene and sanitation promoters and training of entrepreneurs.

Therefore, it is believed that, this manual is a living document and will solve technical and environmental challenges that households are facing to use sanitation facilities in a sustain manner and contribute to improvement of the household sanitation facility quality.

Finally, the MoH is fully committed in making sure this manual is used by all sanitation and hygiene stakeholders and calls up on private sectors, entrepreneurs and development partner organizations to consistently use the manual for hygiene and sanitation promotion.

**H.E. Dr. Kebede Worku**  
**State Minister of Health**





## Acronyms

<b>CIS</b>	Corrugated Iron Sheet
<b>CLTSH</b>	Community Led Total Sanitation and Hygiene
<b>EDHS</b>	Ethiopian Demographic and Health Survey
<b>FMoH</b>	Federal Ministry of Health
<b>GOE</b>	Government of Ethiopia
<b>GTP-II</b>	Growth and Transformation Plan-II
<b>HC</b>	Health Center
<b>HEP</b>	Health Extension Program
<b>HEW</b>	Health Extension Workers
<b>HSTP</b>	Health Sector Transformation Plan
<b>IRT</b>	Integrated Refresher Training
<b>JMP</b>	Joint Monitoring Program
<b>LTO</b>	Latrine Technology Option
<b>OD</b>	Open Defecation
<b>ODF</b>	Open Defecation Free
<b>TVET</b>	Technical and Vocational Education and Training Agency
<b>UNICEF</b>	United Nations Children's Fund
<b>WHO</b>	World Health Organization

## Operational Definitions

### Basic Unimproved Latrine

Sanitation facility that does not provides either privacy and does not separate human excreta from human contact

### Durable Lining Materials

Are pit lining materials that does not damaged by rotting, termite or flood (e.g., stone, fired bricks and reinforced concrete ring)

### Highest Ground Water Table

Ground water level after the end of rainy season

### Improved Latrine

Improved sanitation facilities are defined as a facility that provides privacy and separates human excreta from human contact

### Sanplat Slab

Concrete slab without reinforcement bar

### Static Ground Water Table

Ground water level after the end of dry season

### Vertical Separation

Distance between bottom of latrine pit and highest ground water table

1

# Introduction

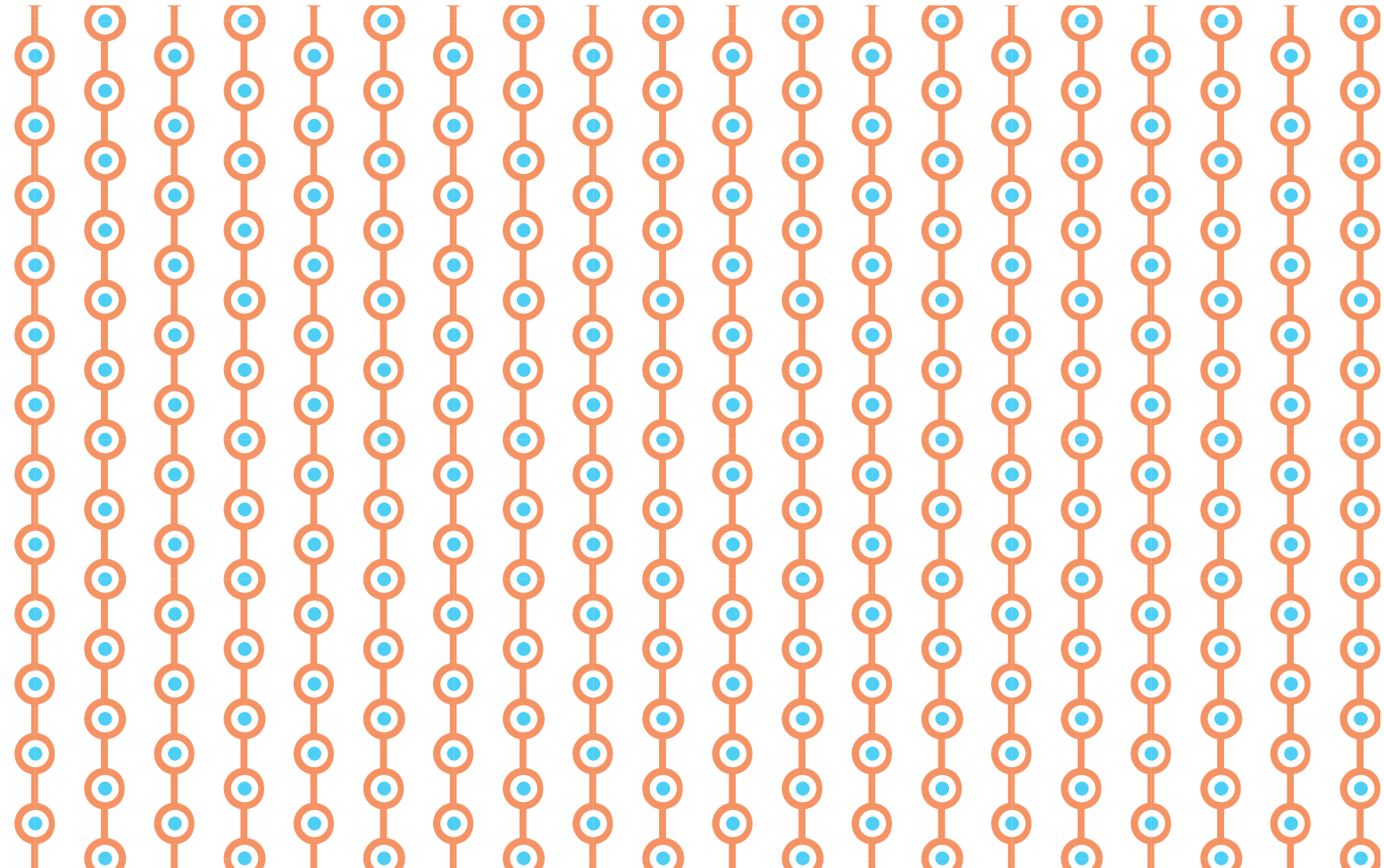

## 1.1 Background Information

Government of Ethiopia is committed for promotion community and household hygiene and sanitation through health extension program (HEP). As a result, promising results has been achieved and large proportion (82%) of the rural households in the country started to use basic latrines (EDHS 2011) and a number of villages and Kebeles managed to achieve primary open-defecation free (ODF) status. Despite high coverage, existing basic unimproved household latrines<sup>1</sup> are observed to be inadequate to remove feces from the environment and contact with humans, thus not halt faeco-oral disease transmission.

Poor quality latrines have a lower lifespan and a higher ongoing maintenance cost. A number of factors have been identified to be associated with short life span of unimproved latrines including; poor construction quality likely due to low profile given to latrine compared to dwelling house and other external factors like collapsing (loose soil), termite problem and flooding problems, which consequently underestimate achievements and hinder households to move up to the next sanitation ladder.

Cognizant of the challenges of existing unimproved latrines, the government has given priority to health service quality improvement in the GTP-II and set target to increase households access to improved latrine facilities<sup>2</sup> from less than 28% to 82% and ODF Kebeles from 18% to 82% at the end of 2020 (HSTP 2016-2020).

To sustain achievements and achieve the set hygiene and sanitation targets, the FMoH has employed two complementary approaches; (i) demand creation using Community Led Total Sanitation and Hygiene (CLTSH) tool and (ii) sanitation marketing strategy to increase households' access to improved sanitation products and services. Increasing the supply and access to improved sanitation technologies or products through market based approaches requires the availability of different options that meet minimum standards to be hygienic and address others social, economical, environmental and technical factors.

Therefore, this Onsite Households Latrine Technology Option Planning, Design and Construction Manual aims to provide a menu of technology (product) options to support the selection, construction and operation and maintenance of latrines.

## 1.2 Users of the Household Latrine Technology Option manual

This manual is prepared to primarily serve the following actors :

- i. **Hygiene and sanitation promoters (HEWs and public health professionals):** support with their routine promotion of improved sanitation, and educate households on the attributes of different types of products to support households engage with entrepreneurs.
- ii. **Entrepreneurs:** as a step by step guide for production of the latrine technology products and construction of household latrines, as well as decision making during business plan development and in promotion of their products to customers.

---

<sup>1</sup> Unimproved latrine is a sanitary facility that does not ensure hygienic separation of human excreta from human contact. Unimproved facilities include pit latrines without a slab or platform, hanging latrines and bucket latrines.

<sup>2</sup> Improved latrine is a sanitary facility that ensure hygienic separation of human excreta from human contact. They include: flush or pour-flush toilet/latrine to piped sewer system, septic tank or pit latrine; ventilated improved pit (VIP) latrine; pit latrine with slab and composting toilet.

- iii. **Technical and Vocational Education and Training (TVET):** A teaching aid during training of sanitation entrepreneurs.

In addition, the manual can serve other stakeholders like;

- iv. **Consumers and latrine users:** to guide individuals who have skills to construct their own latrine facilities; to guide selection of latrine type; and to support for routine operation and maintenance of their latrine.
- v. **Civil Society Organizations:** to support promotion of household and community hygiene and sanitation, as well as a tool for community and organization trainings.

### 1.3 Safe Disposal of Human Excreta

Containment of human excreta is the initial stage of human waste management in the sanitation value chain. All effective onsite sanitation technology options (dry or wet sanitation systems) are designed to safely contain human excreta and prevent exposure to human and environment. However, mere access to adequate sanitation technologies is not sufficient to prevent diseases transmission in the absence of hygiene practices. Therefore, keeping latrines clean and washing hands with soap after latrine visits are equally important to interrupt fecal-oral disease transmission.

In general, household latrine technology options are expected to meet minimum criteria so as to safely manage human excreta (feces and urine) to minimize health risks. To address this issue, the FMOH has adapted criteria for improved latrine from WHO/UNICEF Joint Monitoring Program and set minimum requirements that household latrines should fulfill to be considered as improved facility (MoH, IRT Manual 2014).

This On-Site Household Latrine Technology Option Planning, Design and Construction Manual is prepared to facilitate selection; design and construction of improved latrine technology options so to encourage sustained safe hygiene and sanitation behaviors that directly contribute to the achievement of government target to improve health status in general and to HSTP Strategic Initiative 4.6 (FMOH, HSTP 2016-2020) in particular.

The manual further provides the users with design, specifications and drawings of a selection of technology options, step by step guidance to construct components of the latrines (substructure, slab and superstructure), and associated costs. It also provides guidance to households and service providers on operational and maintenance of the facilities, and safety measures during construction of the latrine.

In general, household latrine technology options are expected to meet minimum criteria so as to safely manage human excreta (feces and urine) to minimize health risks.

# 2

## General Considerations to **Choose Type of Latrine**

This chapter provides information to support users and producers make informed decisions to choose the most appropriate type of latrine technology, including technical, socio-economic and environmental considerations.

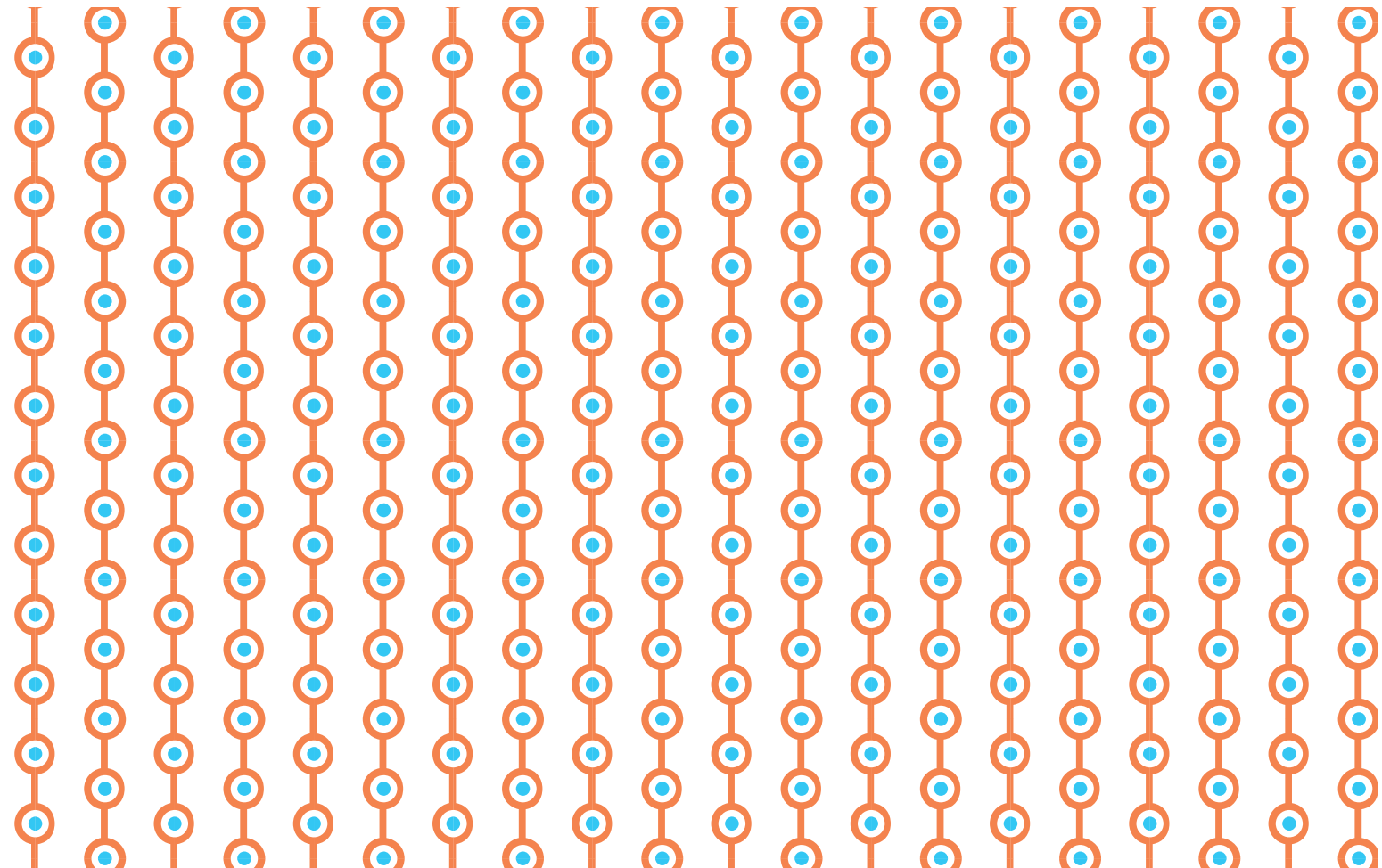

### 2.1 Existing Rural latrine technology options, and related merits and demerits

In Ethiopia, there are many examples of different types of latrine technologies that have been constructed by the households for human excreta disposal (hygiene and sanitation protocol 2006). Those technology options at the bottom of the “sanitation ladder” (Figure 1) are basic or unimproved, low cost but likely pose high health risk to the users and the community as they do not adequately separate excreta from human, flies and environment. Whereas, households are encouraged to move up sanitation ladder by adopting improved sanitation technologies that interrupt Faeco-oral disease transmission.

As the vast majority (98%) of the rural households has no household water connection and technology options to be addressed in this manual are mainly the dry on-site technology options.

**Figure 1:** Ladder of the Household Latrine Technology Options

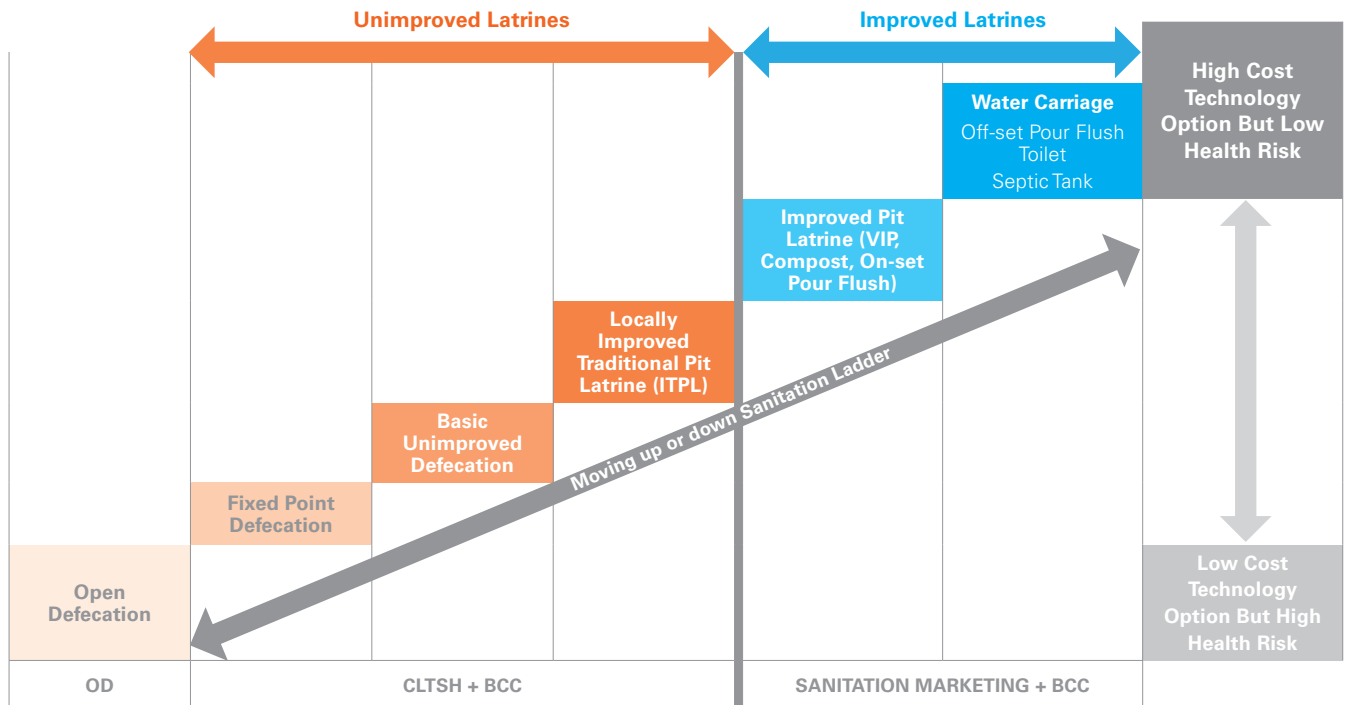

The following table (Table 1) describes different types of latrine technologies to be considered and with their corresponding merits and demerits.

**Table 1:** Household Latrine technology options, advantages and disadvantages and factors for selection

Existing Household Latrine Technology options	Description	Advantages	Disadvantages
<b>Improved Pit latrines (IPL)</b>	<p>Improved Pit Latrine (IPL) consists of a pit excavated into the ground, covered with a mud plastered wooden materials (cleanable) and /or with concrete SanPlat slab with no rebar (washable) with a squat-hole through which excreta fall into the pit and fitted with tight squat-hole cover.</p> <p>Improvements made include the wall provides adequate privacy, no opening on the floor other than squat-hole, and the substructure is constructed from stable/durable materials and provided with hand washing facilities.</p>	<ul style="list-style-type: none"> <li>- Easy to build using locally available construction materials</li> <li>- Suitable for people using leaves, paper, or hard/bulky materials for anal cleansing</li> <li>- Mud plastered floor with no opening (except squat hole) and fitted with tightly fit squat-hole cover</li> <li>- Floor Easily cleanable</li> <li>- Does not need water for operation and suitable for majority of rural households</li> <li>- Easy for operation and maintenance</li> <li>- Appropriate and affordable for low income households</li> <li>- Can be constructed by the household/ unskilled labor with some guidance</li> </ul>	<ul style="list-style-type: none"> <li>- If the whole depth of pit wall is not lined with durable material, it needs new latrine to be constructed (re-digging of pit) when the existing latrine becomes full</li> <li>- Mud plastered floor is not washable</li> <li>- Not appropriate where space/land is a problem</li> <li>- Floor can easily decay or affected by termite</li> </ul>
<b>Ventilated Improved Pit (VIP) latrines</b>	<p>Ventilated Improved Pit latrine is a pit latrine where odor and flies are effectively controlled by the action of a vent pipe. The atmospheric air enters through squat-hole and pushes out odorous gases (hydrogen sulfide and methane gases) generated in the pit through vent pipe.</p> <p>The inside of the super structure is kept semi-dark so that emerging flies would be attracted by the sun light that comes through the vent pipe and not the drop hole.</p>	<ul style="list-style-type: none"> <li>- Easy to build using locally available materials</li> <li>- Relatively low cost of construction</li> <li>- Suitable for people using bulky anal cleansing materials (leaves, paper, or hard materials)</li> <li>- Suitable for water scarce areas (does not need water for operation)</li> <li>- Significantly reduces smell in the latrine and flies</li> <li>- Floor/slab is washable</li> <li>- Does not need squat-hole cover</li> <li>- Easy for operation and maintenance</li> </ul>	<ul style="list-style-type: none"> <li>- Requires masonry and carpentry skills</li> <li>- In areas where there is hollow bamboo, it needs to buy PVC vent pipe (additional cost)</li> <li>- Needs new latrine to be constructed when the existing latrine becomes full</li> <li>- Interior part of the superstructure should be kept dark to discourage fly movement and egress through the squatting hole</li> <li>- Not affordable for low income households</li> </ul>



Existing Household Latrine Technology options	Description	Advantages	Disadvantages
<b>Compost latrine (Arborloo and double vault compost latrine)</b>	<p>Compost latrine of different types are among the dry pit latrines suitable for areas with hard (rock soil) formation which is difficult to excavate the pit to the required depth. Household can close the old pit and grow fruit plants and construct and use new pit.</p> <p>Compost latrine also suitable option for households living in a densely populated settlement where space for construction of latrine is a critical problem. It allows households to empty and reuse the pit. In addition, adequately decomposed excreta can be used for soil conditioning (fertilizer) after two years.</p>	<ul style="list-style-type: none"> <li>– It is dry latrine option in areas with rocky soil formation (difficult to dig) and shallow water table</li> <li>– Suitable for households willing to use decomposed excreta for fertilizer</li> <li>– No risk for ground water contamination</li> <li>– Can be built nearby the dwelling house</li> <li>– Double vault composting latrine is sustainable and can be alternatively used for long time</li> <li>– Slab can be transferred to new pit when old one becomes full</li> <li>– Tree can be planted in the old pit of Arborloo latrine to take advantage of using the compost</li> </ul>	<ul style="list-style-type: none"> <li>– Less acceptable in conservative culture to use latrine content for fertilizer/soil conditioning</li> <li>– Needs saw dust and ash to cover the feces after defecation</li> <li>– Arborloo type of compost latrine needs space to rebuild new when the old latrines become full again and again</li> <li>– Arborloo latrine is not suitable where space is a problem (in densely populated areas), and areas affected with frequent flooding</li> <li>– Planting vegetables in abandoned Arborloo pit latrine before a year is hazardous to public health</li> <li>– It requires training of households on handling, preparation of compost and use of fecal matters</li> </ul>
<b>Off-set pour flush latrine</b>	<p>A Pour Flush latrine is a wet latrine type that uses 2-4 litres of water/use to flush or convey faecal matter from a pedestal or squatting pan to a soak pit. A soak away pit can be located directly below the pan or can be offsite.</p> <p>In case of an offsite pit, a drainage pipe that conveys excreta to the pit is connected to the outlet of the pan water seal trap and to the soak pit at a slope of 30%.</p>	<ul style="list-style-type: none"> <li>– It is wet latrine option which needs water for day to day use and operation (2-4 litre water per flush/use). Appropriate option for households who have water supply connection at least in the yard (living plot)</li> <li>– Water seal prevent fly breeding and bad smell</li> <li>– Installation needs masonry and plumbing skills</li> </ul>	<ul style="list-style-type: none"> <li>– Cannot operate where water is not available for flushing</li> <li>– Installation and maintenance costs are relatively expensive (high)</li> <li>– Owner with no masonry and plumbing skill cannot maintain or repair the latrine and revert to open defecation immediately after the system fails to function</li> <li>– Cannot be Installation and maintenance costs are relatively expensive (high)</li> <li>– Requires soft/tissue paper or water for anal cleansing and easily clogged if solid materials are used</li> </ul>

## 2.2 Special considerations for selection of the latrine types and site selection

There are a number of factors important to be considered to determine type, design, and location/sitting of latrine technology options.

**Table 2:** Description of factors that determine choice of type, design and location of Household latrines

Factors	Explanations
<b>Soil type</b>	<p>Soil type and permeability affect the selection and design of the latrines. It determines depth of pit to be excavated and to determine vertical separation between the bottom of the pit and highest ground water table. For example the load carrying capacity of the soil, self-supporting properties of the pit against collapse (cohesive soil), risk of ground water pollution (to determine desired depth) and soil infiltration rate.</p> <p>Micro-organisms quickly move in porous type of soil compared to compacted soil type. Therefore, Vertical separation (soil thickness) between the bottom of latrine pit and highest ground water table should not be less than 5 meters to reduce pathogens either through actions like filtration, dilution, predation, and die off</p>
<b>Level of ground water table</b>	<p>Highest level of ground water table is important factor that determine the depth of pit and type of latrine to be selected. In addition, determination of the latrine sitting (location) should take in to consideration existing ground water sources of the owner and of the neighboring households.</p> <p>There are possibilities that pit latrines can pose contamination risk to the groundwater. The bottom of pit may be above the water table during the end of rainy season. However, the liquid part of pit content will soak into the surrounding soil and seeps down through the soil and contaminate/enter the aquifer.</p>
<b>Location: proximity to water sources</b>	<p>If the latrine is built uphill of the existing water source, the liquid content of the latrine could also seep in to the soil, flow downhill and contaminate the water source. Therefore, the latrine should be located downhill 30-50 meters from the water source</p>
<b>Accessibility to users</b>	<p>Too far latrines are less utilized by some of the family member such as pregnant mothers, small children, aged and those with disabilities, and unlikely to be used during the night and raining. Therefore, it should be sited 6 to 15 meters from the dwelling house at the backyard.</p>
<b>Access to construction materials and Cost</b>	<p>Materials for construction of latrine products (for lining of pit, production of slabs, wall and roofing) are not uniformly available in the environment and market in different parts the country. Wooden materials are scares in the Northern part of Ethiopia and stone is rarely available in the south and west of the country. Unavailability of durable construction materials in the area increases cost of production of sanitation products.</p> <p>In addition, households make choice of latrine technology based on their ability to pay for the construction of the latrine and operation and maintenance. Households in low socio-economic position (low income) may not have enough cash to buy improved sanitation and hygiene products. As a result, they face difficulties to climb up the sanitation ladder. Such households are encouraged to improve their basic latrines with locally available materials</p>
<b>Availability of water</b>	<p>Easy access to water is important for selection of latrine option. Selection of wet latrine technology option at very outset depends on the household water availability and its continuous supply. If the household has no water connection in the yard, the most appropriate technology option is dry pit latrines</p>
<b>Culture (traditional beliefs)</b>	<p>Considering social and cultural issues like traditional beliefs in different nations and nationalities in Ethiopian communities is important when selecting latrine site, easy use by women during night (avoid fear of violence and wild animals), during rain, away from road, family relationships (taboos like sharing of the same latrine with father in-low in Gedeo and Sidama communities), cleansing practices, and housing density.</p> <p>In addition, Muslim does not like to face Macca as they defecate. So the latrine and the slab foot rest should face other directions. For easy washing, they also prefer squatting pan to sitting type. On the other hand, use of biologically degraded fecal matter as a soil conditioning and fertilizer is not accustomed and people may not feel comfortable to touch the compost by hand.</p>

# 3

## Basic Components of **Household Latrine**

This chapter provides information on (i) the basic components of the pit latrine and the materials that can be used to construct these components; (ii) functions of the components, and reasons why pit latrines are often not operated and maintained properly

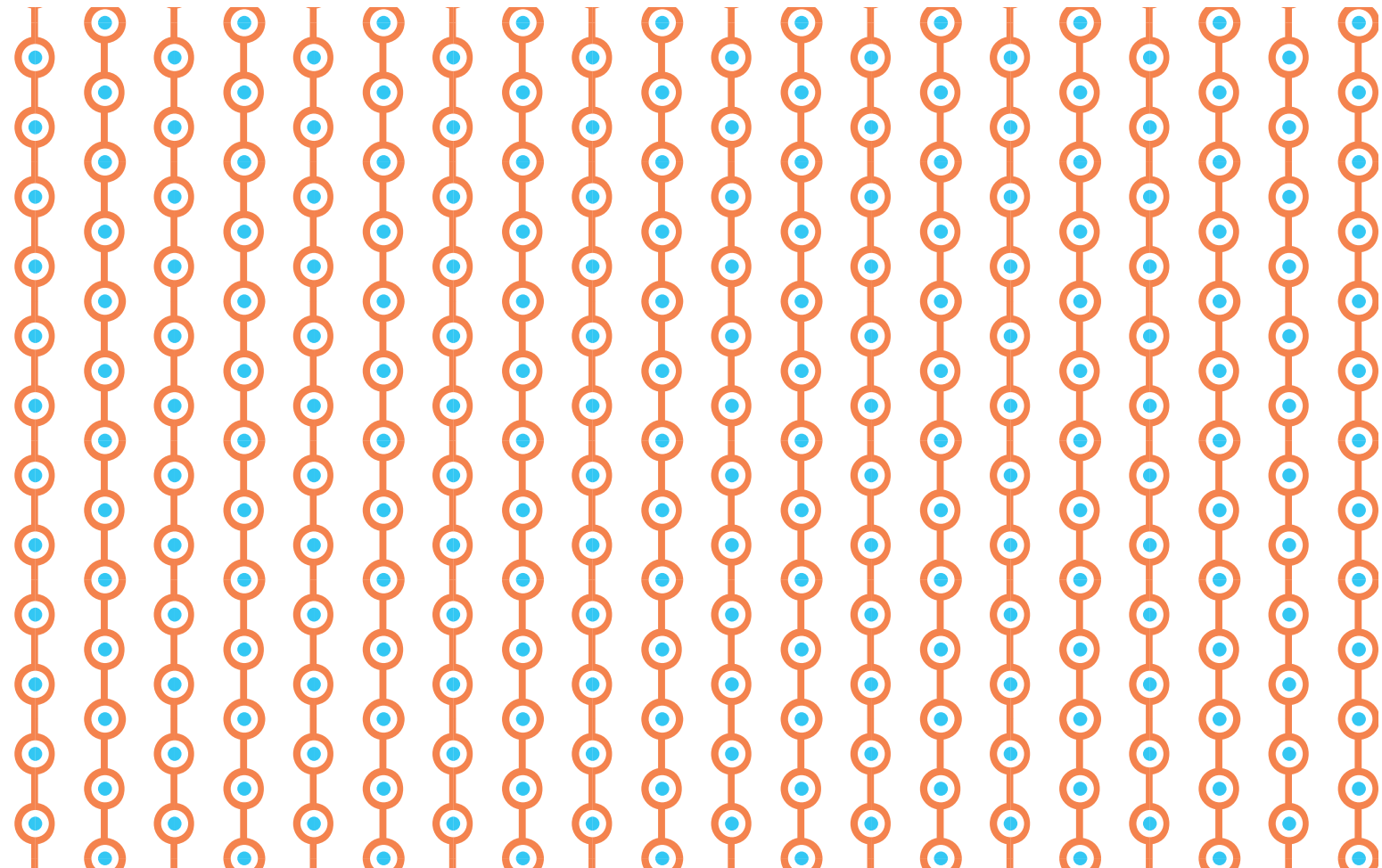

### 3.1 Basic component of the latrine

Pit latrines have three basic components: Substructure (the pit and pit lining), the floor (slab and mound), and the superstructure (wall, roof and door).

#### 3.1.1. Substructure

It is component below the ground which include pit and its lining

- Used to store human excreta (faeces and urine) and supports pit cover (slab) and shelter
- Shape can be circular, square or rectangular
- Volume of pit is determined based on family size, design period and ground water table
- Top 500mm depth of the pit wall is lined by durable material (stone, bricks, or concrete) to prevent entrance of rodents and run-off
- Pit is lined if the soil type is loose (sand, clay/silt) and high ground water table
- Lining of Pit with durable material prevents pit wall from collapsing (caving in),
- Pit lined with durable materials are reusable

Pit could be lined with stone, bricks, precast concrete ring, ferrocemnet, wooden logs or bamboo

#### 3.1.2. Floor

**Floor** is the component above substructure that comprises of slab and mound

- The slab is the term use to describe the cover of the pit
- Supports the user and the wall
- If latrine is VIP, it has two holes (one squat-hole and second is for vent installation)
- If the latrine is not VIP it should have squat-hole cover
- Slab can be produced from plastic, reinforced concrete, or wooden materials
- Shaper of the slab can be circular, rectangular or square – the same as the shape of the pit

#### **Mound**

- Compacted soil or durable materials around the latrine above the ground)
- It prevents entrance of run-off and rodents
- A recommended size would be 150 – 200mm above the ground

#### 3.1.3. Superstructure

It comprises wall and roofing

- Walls provides privacy to the user
- Walls and roof prevent user from rain, wind draft sunlight and heat
- Prevents wooden slab from rotting as a result of rain
- Wall can be constructed from locally available materials either from stone, bricks, corrugated iron sheet, wood, bamboo, grass, or polyethylene plastic sheet.
- Roof can be constructed either from Corrugated Iron Sheet, grass or polyethylene plastic sheet
- Walls above door can be left open screened with iron mesh (lighting and ventilation)
- If the latrine is VIP,
  - > Inside the of the latrine kept dark to discourage flies to come out through squat-hole
  - > Vent is installed height inside or outside of the wall with 500mm height above the roof top and covered with mesh wire/fly screen

# 4

Hand tools for

## **Construction of the Latrine**

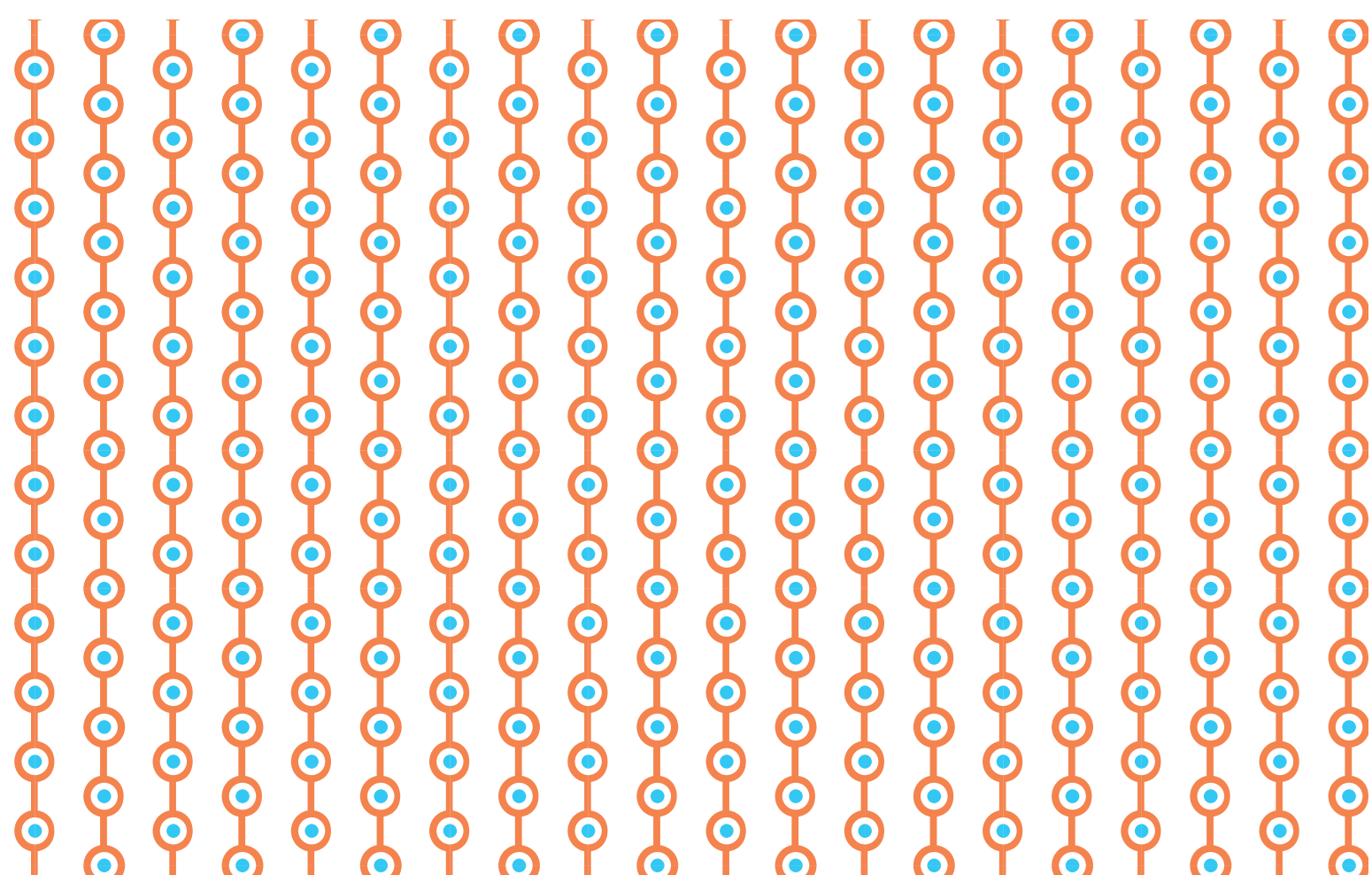

Construction of latrine requires different types of masonry, carpentry and plumbing hand tools. Essential hand tools are listed in table 3 below

**Table 3:** List of construction hand tools

**Description of Essential Hand Tools**

<b>A Mason's and Plumber's hand tools</b>	
1	Mason's hammer
2	Shovel
3	Spade
4	Wire cutter (Pinsa)
5	Hacksaw with blade for cutting iron bar
6	Sprit level
7	Mason's plum bob (Tumbi)
8	Metal Trowel for smoothening/finishing of concrete
9	Wood for screeding
10	Squat-hole mould
11	Wooden floats
12	Foot rest mould -left and right
13	Straight, smooth and clean Wooden frame (formwork) thickness for preparation of mould (slab, foot rest and squat-hole)
14	Personal Protection devices (Plastic helmet, eye goggle, pairs of leather or rubber shoes and Heavy duty gloves)
15	Rope, 0.5mm thickness
16	Measuring tape of 3 meters
17	Plastic sheet for shading in Sq.m
18	Jerry can of 20 liters
19	Bucket (Shenkelo)
<b>B Carpenter's hand tools</b>	
1	Carpenter Hammer (Martello)
2	Carpenter's sprit level
3	Carpenter's plum bob (Tumbi)
4	Hand saw
5	Measuring tape of 3 meters
6	Rope, 0.5mm thickness
7	Personal Protection equipment (eye goggle, Pairs of leather or rubber shoes, and Pairs of Heavy duty gloves)

# 5

## Latrine Component Selection and Construction

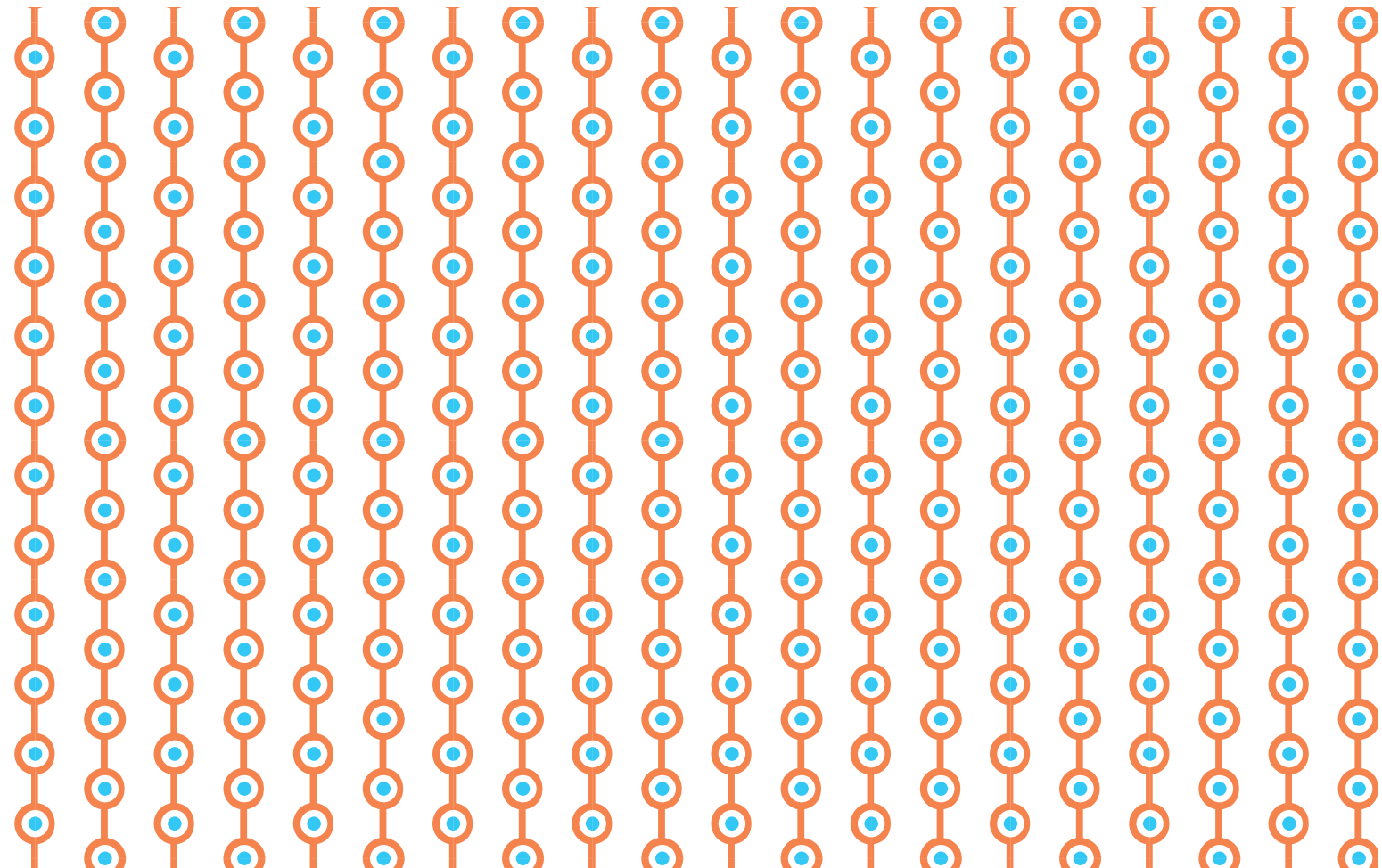

## 5.1. Identification of Soil type

Soil type may vary from site to site in the same village. Information about soil type of particular site is important to choose the suitable latrine option and decide materials to be used for construction of substructure (below or above the ground), floor and for the superstructure. The following table describes basic characteristics of different soil types.

There are three major types of soil with distinctive characteristics namely; sand silt and clay.

### 1. Sandy Soil:

Sandy soil is loose (not sticky) with regular shape, has largest particle size ranging from 0.05mm – 2mm in diameter and rough on touching. There are huge spaces (porous) between sand particles and therefore cannot retain water. Such soil type is good to soak away liquid part of latrine content in the surrounding soil.

### 2. Silt soil:

Silt is slightly sticky with irregular shape, moderately absorb and retain water with particle size ranging from 0.002mm – 0.005mm in diameter.

### 3. Clay soil:

Clay highly sticky which is difficult to see particle size with naked eye, flat in shape, with high water absorption and retention capacity and particle size less than 0.002mm in diameter.

**Figure 1:** Soil Types Particle Sizes

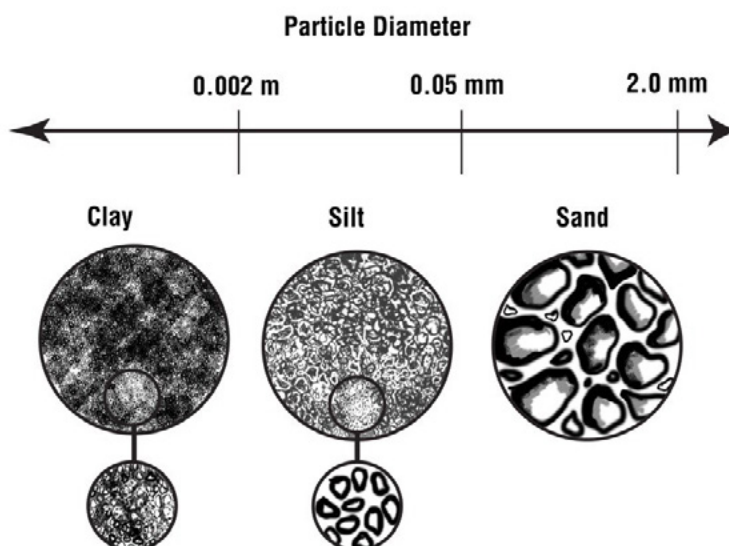

In summary, consistency and stickiness of the soil in that particular site /place important to decide the dimension of the latrine pit, determine whether to partially or fully line the pit wall and bottom, and select appropriate lining materials. Therefore, the following information described in Table 4 can support any person intended/planned to promote or construct latrine including individual households, PHCU staff and entrepreneurs.



**Table 4:** Description of Soil type and its consistency and stickiness

Soil Characteristics	Description
<b>I. Soil consistency</b>	
<b>1. Loose</b>	– Will not stick together up on touching
<b>2. Soft</b>	– Soil mass is weakly coherent and fragile – Breaks to a powder – Individual grains are under very slight pressure
<b>3. Slightly hard</b>	– Weakly resistant to pressure – Can be broken between thumb and forefinger
<b>4. Hard</b>	– Moderately resistant to pressure – Can be broken in the hand without difficulty – Hardly breakable between thumb and forefinger
<b>5. Very hard</b>	– Very resistant to pressure – Can be broken in the hand only with difficulty – Not breakable by thumb and forefinger
<b>6. Extremely hard</b>	– Very resistant to pressure – Cannot be broken in the hand
<b>II. Soil stickiness when wet: pressing with thumb and forefinger</b>	
<b>1. Not sticky</b>	– After release of pressure, no soil material adhere to thumb and forefinger
<b>2. Slightly sticky</b>	– After release of pressure, soil material adhere to thumb and forefinger, but comes off after one's
<b>3. Sticky</b>	– After release of pressure, soil material adhere to thumb and forefinger – Soil material tend to stretch
<b>4. Very sticky</b>	– Soil material adhere to thumb and forefinger strongly

## 5.2. Substructure Size and Material Selection

### 5.2.1 Choosing Pit Lining Materials

Selection of the pit lining materials is contingent to the type and characteristics of soil in the area. The following Table 5 provides information to choose suitable and affordable pit lining materials that is strong enough to prevent the pit from caving-in and to support the slab, user and superstructure.

**Table 5:** Soil type and materials suitable for pit lining

Soil Type	Suitable pit lining materials		Remark
	Durable lining materials	Other alternative lining materials	
<b>1. Stable soil</b>	Selected soil material, stone, bricks, or concrete beam	Selected soil material	Top 500mm depth to prevent entrance of runoff and vermin
<b>2. Sandy (fragile and loose)</b>	Precast reinforced concrete ring	-	
<b>3. Silt/clay soil</b>	Stone, fired bricks, or precast reinforced concrete ring	Wood or bamboo	Full or partial lining of the wall by durable
<b>4. Rocky (hard to dig) soil</b>	Stone or fired bricks above the ground	-	Soil mounding is needed around the structure above the ground
<b>5. Higher water table and Water Logging</b>	Water tight concrete bottom/ base, precast reinforced blind concrete ring	-	Pit digging during the dry season and water tight lining protruded above the ground

## Pit Lining Options

**Figure 2:** Lining with Stone

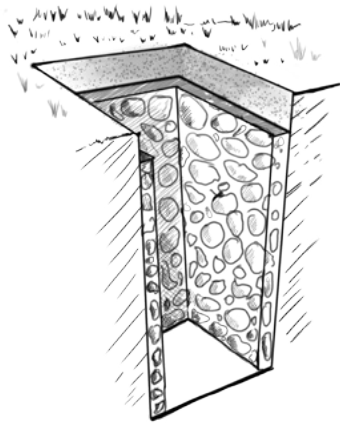

Lining with Stone

**Figure 3:** Lining with Bricks

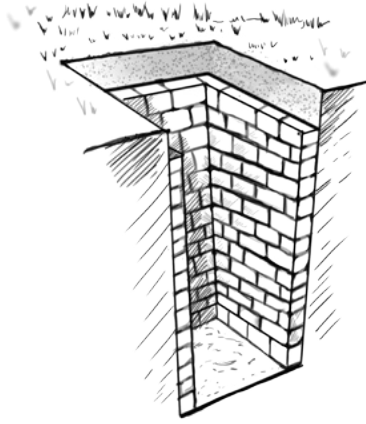

Lining with Bricks

**Figure 4:** Precast Reinforced Concrete Ring



Precast reinforced concrete ring

**Figure 5:** Lining with Wooden Log

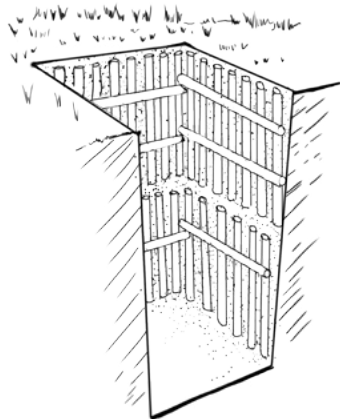

Lining with Wooden log

**Figure 6:** Lining with Woven Bamboo

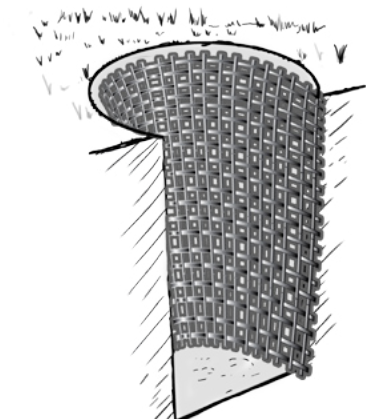

Lining with Woven Bamboo

**Figure 7:** Lining top 500mm with stone or bricks

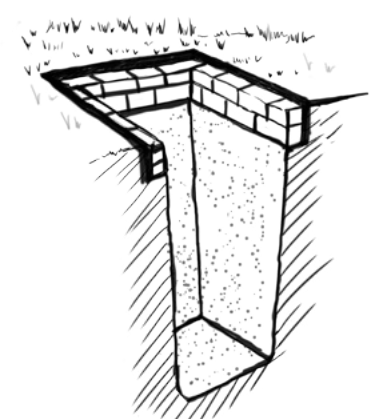

Lining top 500mm with stone or bricks

### 5.2.2. Determine the Pit dimension and Volume of Lining Materials

Some key characteristics of a latrine pit include;

- Adequate capacity to store faeces/sludge and materials used for anal cleansing (such as water, leaf or paper),
- Sufficient space/depth to cover contents when it is about to fill,
- Appropriate depth to prevent surface water and soil contamination with disease pathogens, and
- Pit wall should allow infiltration of liquid content of the faeces during its operational life
- In addition, the required dimensions of the latrine pit (length, width and depth or diameter and depth) is determined based on minimum space (working area) to a person who excavate the pit, type of lining materials to be used, and space available in the compound.

Factors to determine pit size

- Annual faecal sludge accumulation rate (SAR)
  - > For dry latrine SAR =  $0.09\text{m}^3/\text{person}/\text{year}$  and
  - > For wet latrine, SAR =  $0.06\text{m}^3/\text{person}/\text{year}$
- Family size (varies from household to household (Average 5 person/household)
- Design period (desired year of operation)
- Lining material to be used
- External diameter of the pit
- Highest ground water table
- Total Depth of the pit (effective depth + top 500mm for pit sealing)

#### Note:

- **Pit with wider diameter incurs additional cost. Because, additional lining material, larger and thicker slab (large concrete slab needs reinforcement by thicker iron bar, additional cement, sand and gravel, labor and transportation cost)**

#### **Pit has both internal and external volume.**

- The internal volume is a free space that serves for storage of human excreta and of soil back filling soil at the top 500mm sealing
- The external volume is the sum of internal volume and additional volume for pit lining material and space for back filling

#### **External volume of the pit varies depending on the thickness lining materials and space for back filling between the lining and the surrounding ground soil**

- Stone lining occupies more space (400mm) including 10mm space for back filling
- Bricks (120mm + 100mm = 220mm) including 10mm space for back filling
- Reinforced concrete ring (110mm)
- Wooden log (100mm + 100mm = 200mm), including 100mm space for back filling
- Woven bamboo (50mm + 100mm = 150mm), including 100mm space for back filling

**Note:**

- Choice for lining material primarily depends on the soil type, availability of the materials in the area, cost of the materials, and labor cost.
- Woven bamboo and Wooden Log lining materials are not durable and cannot support for more than 2 ½ to 3 years and its support function is loosened if effective depth of pit deeper than 2 meters.

**Figure 8:** Pictorial description of internal and external diameter of a circular pit [Example]

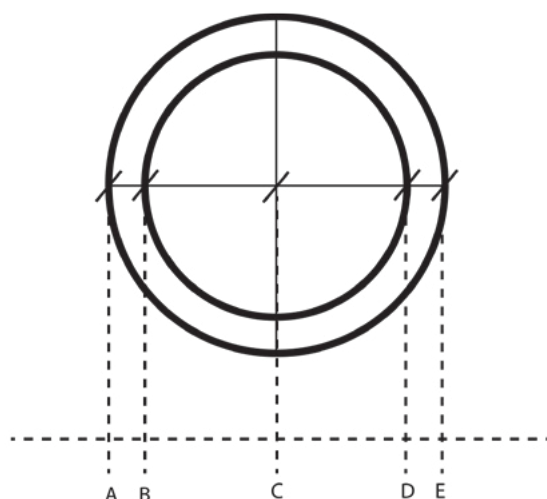

*AE (external diameter of the pit) – varies depending on the lining material to be use*  
*BD (internal diameter of the pit) – is the same for all lining material (e.g. 1000mm or 1m)*  
*BC = CD (Internal Radius of the pit) – is the same for all lining material (e.g. 500mm or 0.5m)*  
*AB = DE (Thickness of the lining material and back filling space) – varies between lining material*  
*AC (External Radius of the pit) – varies between lining material*

**Table 6:** Internal and external dimensions of circular pit and lining material options (Example)

Lining material	Circular Latrine Pit				
	Internal diameter of the pit (bottom)	Internal radius of the pit (at Bottom)	Thickness of the lining material	External diameter of the pit (bottom)	External Radius
Stone	1000mm	500mm	400mm	1800mm	Radius 900mm
Bricks	1000mm	500mm	220mm	1440mm	Radius 720 mm
Concrete Ring	1000mm	500mm	150mm	1300mm	Radius 650mm
Wooden Log	1000mm	500mm	100mm	1200mm	Radius 700mm
Woven Bamboo	1000mm	500mm	50mm	1100mm	Radius 550mm

**Example: Determine effective pit size (dimension)**

For example, Ato Abebe has a family size of 5 people. His family started to use latrine in 2006 EFY and since then he has built three latrines (one every year) after each rainy season. He has planned to build a long lasting dry pit latrine that can serve at least for five years. The latrine he intended to build is with internal diameter of 1000mm (1m) to use for at least 5 years. Type of the soil in the area is clay soil which is unstable and pit easily collapse. All types of pit lining materials are available in the village and in the neighboring village. Mason and daily labor workers are available in the nearby town. Ato Abebe wanted to know and make choice of affordable lining material, quantity of lining material, cost of materials, labor cost for excavation and lining of the pit.

Given:

Type of latrine option is dry pit latrine

- Soil type is loose soil (silt-clay soil type)
- Family size = 5 persons
- Desired year of operation = 3 to 5 years
- Internal diameter of the Pit (circular) = 1000mm or 1m at its bottom
- Sludge accumulation rate (SAR) = 0.09m<sup>3</sup>/person/year
- All types of lining material option are available in the area
- Mason and daily labor workers available in the nearby town

Using the above case,

- Determine effective pit size (volume, pit area, and depth) for sludge accumulation,
- Determine total pit size (volume) to be excavated considering different lining materials
- Determine volume of different lining materials
- Estimate cost of the lining material, unskilled and skilled labor for substructure construction

**Step 1: Calculate effective volume** for storage of excreta by multiplying number of family size (5 people) by desired year of operation (example; 5 years for durable materials such as stone, bricks and concrete ring, 3 years for wooden and 2 ½ years for bamboo) and then multiple by factor for sludge accumulation rate for dry pit latrine (0.09m<sup>3</sup>/person/year).

**For durable lining materials (stone, bricks and precast reinforced concrete ring)**

- Effective pit volume (durable) = 5 people x 5 years x 0.09 m<sup>3</sup>/p/y Sludge accumulation rate = 2.25m<sup>3</sup>
- Effective pit volume (wooden) = 5 people x 3 years x .09 m<sup>3</sup>/p/y Sludge accumulation rate = 1.35m<sup>3</sup>
- Effective pit volume (bamboo) = 5 people x 2½ years x .09 m<sup>3</sup>/p/y Sludge accumulation rate = 1.13m<sup>3</sup>



**Step 2:** Calculate **EFFECTIVE AREA** of the of the pit using formula ( $A = \pi r^2$ ), where  $\pi r^2 = 3.14$  and  $r =$  radius of effective pit = 0.5m, then **Internal Area = 3.14 x 0.5<sup>2</sup> = 0.79m<sup>2</sup>**



**Step 3:** Calculate **EFFECTIVE DEPTH** of the pit (by dividing effective volume by effective area) for each pit lining materials

- Effective depth for durable materials = 2.25m<sup>3</sup> divided by 0.79m<sup>2</sup> = 2.85m
- Effective depth for wooden material = 1.35m<sup>3</sup> divided by 0.79m<sup>2</sup> = 1.71m
- Effective depth for bamboo materials = 1.13m<sup>3</sup> divided by 0.79m<sup>2</sup> = 1.43m



**Step 4:** Calculate the **TOTAL DEPTH** of the pit (by adding 0.5m on effective depth)

- Total depth for durable lining material = 2.85m + 0.5m = 3.35m
- Total depth for Wooden lining material = 1.71m + 0.5m = 2.21m
- Total depth for Bamboo lining material = 1.43m + 0.5m = 1.93m



**Step 5:** Calculate **INTERNAL VOLUME** of the pit (multiply **internal area** of the Pit by **total depth**)

- Internal volume (durable materials) = 0.79m<sup>2</sup> x 3.35m = 2.65m<sup>3</sup>
- Internal volume (wooden materials) = 0.79m<sup>2</sup> x 2.21m = 1.75m<sup>3</sup>
- Internal volume (Bamboo materials) = 0.79m<sup>2</sup> x 1.93m = 1.52m<sup>3</sup>



**Step 6:** Calculate **EXTERNAL AREA** of the Pit (using formula ( $A = \pi r^2$ ), where  $\pi r^2 = 3.14$  and  $r =$  external radius of pit (this varies for each lining material option)

- EXTERNAL AREA of the Pit (Durable-stone) = 3.14 x 0.9m<sup>2</sup> = 2.54m<sup>2</sup>
- EXTERNAL AREA of the Pit (Durable-Bricks) = 3.14 x 0.72m<sup>2</sup> = 1.63m<sup>2</sup>
- EXTERNAL AREA of the Pit (Durable-Concrete Ring) = 3.14 x 0.65m<sup>2</sup> = 1.33m<sup>2</sup>
- EXTERNAL AREA of the Pit (Wood log) = 3.14 x 0.7m<sup>2</sup> = 1.54m<sup>2</sup>
- EXTERNAL AREA of the Pit (Bamboo) = 3.14 x 0.55m<sup>2</sup> = 0.95m<sup>2</sup>



**Step 7:** Calculate **EXTERNAL VOLUME** of the pit (multiplying **external area** of the pit by **total depth**)

- External volume of the pit (Stone): 2.54m<sup>2</sup> x 3.35m = 8.5m<sup>3</sup>
- External volume of the pit (Bricks): 1.63m<sup>2</sup> x 3.35m = 5.46m<sup>3</sup>
- External volume of the pit (Concrete ring): 1.33m<sup>2</sup> x 3.35m = 4.5m<sup>3</sup>
- External volume of the pit (Wooden): 1.54m<sup>2</sup> x 2.21m = 3.4m<sup>3</sup>
- External volume of the pit (Bamboo): 0.95m<sup>2</sup> x 1.93m = 1.83m<sup>3</sup>

**Table 7:** Summary of pit size/dimension for different pit lining material options [Example]

Pit dimension parameter	For example; a dry on-site circular shape with internal bottom diameter of 1000mm (1m) latrine pit for family size of 5 person per household, with sludge accumulation rate of 0.09 cubic meter per person per year, and desired year of operation for 5 years for durable lining materials, 3 years for Wooden and 2 ½ years for Bamboo lining						
	Step	Lining with Stone	Lining with Fired Bricks	Lining with precast reinforced concrete ring	Lining with Wooden Log + Top 50 Cm	Lining with woven bamboo + top 50cm	Only Top 50 cm lining with stone/ bricks
Average number of Family Size	Given	5	5	5	5	5	5
Desired year of operation in Years	Given	5	5	5	3	2.5	5
Sludge accumulation rate per person per year for dry pit latrine (SAP)	Given	0.09	0.09	0.09	0.09	0.09	0.09
Effective pit volume in cubic meter	Step 1	2.25	2.25	2.25	1.35	1.13	2.25
Effective Area of the pit in Sq.m.	Step 2	0.79	0.79	0.79	0.79	0.79	0.79
Effective Pit depth in meter	Step 3	2.85	2.85	2.85	1.71	1.43	2.85
Total depth of the pit in meter	Step 4	3.35	3.35	3.35	2.21	1.93	3.35
Internal Volume of the pit in cubic meter	Step 5	2.65	2.65	2.65	<b>1.75</b>	<b>1.52</b>	<b>1.57</b>
External Area of the Pit in Sq.m.	Step 6	2.54	1.63	1.33	1.54	0.95	1.96
External Volume of the Pit in cubic meter	Step 7	8.5	5.46	4.5	3.4	1.83	

**Note:**

- External Volume of the pit is equal to total volume of the pit to be excavated

**5.2.3 Volume and Cost of the Pit Lining Options**

Unstable, loose and less compacted soil formation that easily collapse needs lining with durable materials. In addition, pit lining materials are also important to prevent ground water contamination in areas where the ground water table is high or in areas where water logging and flooding is a prevalent.

Quantities (volume) of pit lining materials and corresponding costs vary depending on the size of the pit and type of lining materials (Table 5.2.3). In addition, Pit lining work requires additional material inputs. For example, stone, bricks and concrete ring needs cement mortar to fix joints

and surface together. Wooden logs need nails to fix together and both wood and bamboo lining needs top 500mm depth to be lined with either stone or bricks joined by cement mortar. All lining work irrespective of the material type requires unskilled labor to cart away excavated soil and assist the skilled labor.

Information about cost of the pit lining materials is important to make choice among lining materials suitable for that particular soil formation that can be constructed at affordable cost. However, cost of the pit lining (materials and labor costs) may vary from region to region, Woreda to Woreda and from time to time depending on availability of construction materials, skills, and labor market in the area.

Table 8 below provides information on how to determine volumes of the pit to be lined using different material options including space for backfilling between pit-lining and the surrounding ground. Information on external and internal volume of the pit is taken from examples given to calculate parameters of pit size under section 6 above

**Table 8:** Example how to determine Volume of the pit to be lined with different lining material options

Lining Material Options	External Volume (volume of soil to be excavated)	Internal Volume (open pit for accumulation of excreta)	Volume of pit to be lined
Stone Lining	3.14 x 900mm x 900mm x 3350mm = 8.52m <sup>3</sup>	3.14 x 500mm x 500mm x 3350mm = 2.7m <sup>3</sup>	<b>5.82m<sup>3</sup></b>
Bricks Lining	3.14 x 720mm x 720mm x 3350mm = 5.45m <sup>3</sup>	3.14 x 500mm x 500mm x 3350mm = 2.7m <sup>3</sup>	<b>2.75m<sup>3</sup></b>
Concrete Ring Lining	3.14 x 650mm x 650mm x 3350mm = 4.45m <sup>3</sup>	3.14 x 0.5 X 0.5 x 3350mm = 2.7m <sup>3</sup>	<b>1.75m<sup>3</sup></b>
Wooden Log	3.14 x 700mm x 700mm x 2210mm = 3.4m <sup>3</sup>	3.14 x 0.5 X 0.5 x 2210mm = 1.6m <sup>3</sup> + Top seal 1.57m <sup>3</sup>	<b>3.22m<sup>3</sup></b>
Woven Bamboo	3.14 x 550mm x 550mm x 1930mm = 1.83m <sup>3</sup>	3.14 x 0.5 x 0.5 x 1930mm = 1.51m <sup>3</sup> + Top seal 1.57m <sup>3</sup>	<b>3.1m<sup>3</sup></b>
Top 50cm Stable Soil	(3.14 x 1m X 1m x 0.5m) = 1.6 m <sup>3</sup>	3.14 x 0.50. x 0.5 = 2.63m <sup>3</sup>	<b>4.2m<sup>3</sup></b>

### Lining Material and Cost Estimation

In the previous section, information was provided about the volume pit to be lined using different lining materials. The next step is preparation of specification and quantification of materials and labor required for the lining of the pit. Durable lining materials need cement mortar to hold materials together. Whereas, wooden and bamboo require nails to fix together. While mason is required to construct durable lining material, a carpenter is need for lining with wooden and bamboo. Unskilled labor is also required for excavation of pit, removing excavated soil, back filling of the space between lining and surrounding soil and to assist the skilled labor. Lining materials and costs can be estimated based on the following assumptions (Box 1) and sample bill of quantities and cost estimation is presented in Table 9 below



**Box 1: Assumptions for quantification and cost of pit lining material options:****Assumptions to quantify lining materials**

- Proportion of mortar to stone masonry work /bricks works= 0.37 Mortar: 0.63 Stone (Bricks)
- Mortar = Cement to Sand ratio = 1: 3 parts
- Wastage rare 25%
- 1m<sup>3</sup> of cement = 3.5 quintals
- 1 piece of Bricks = 0.0017m<sup>3</sup>
- Wooden log diameter of 100mm
- Bamboo diameter of 50mm
- Back filling space between lining and surrounding soil= 100mm (thickness)

**Assumption for cost estimation**

- Unskilled labor for pit excavation, removing away excavate soil from areas of the pit,
- Semi skilled labor (assistant mason / carpenter)
- Skilled labor (mason/carpenter)
- Purchasing and transportation cost of lining material options (stone, bricks, cement, gravel, nails, wood, or bamboo)

**Table 9:** Pit Lining material specification and cost estimation

Pit lining material options	Description of materials and works	Unit	Quantity	Unit price	Total price
Lining of pit with <b>stone joined by concrete mortar</b> and back filling of the open space between the lining and the surrounding soil Ratio of cement Mortar = 1 cement :3 parts sand	Excavation 8.6 cubic meter circular Pit (diameter of 1800mm and depth 3400mm)	Cub. m	8.6		
	Remove the excavated soil 50 meters away from the construction site/location	Man day	10		
	Dry Masonry stone	Cub. m	5		
	Sand	Cub. m	3		
	Cement bag of 50 kg	Bags	6		
	Gravel	Cub. m	1.9		
	Back fill open space with 1.92 cubic meter gravel between lining and the surrounding soil (100mm x5650mm x 3400mm)	Man day	3		
	Semi Skilled Labor (2 assistant)	Man day	8		
	Skilled labor	Man-day	4		
Total cost for pit lining with stone					

Pit lining material options	Description of materials and works	Unit	Quantity	Unit price	Total price
Lining of pit with <b>fired bricks joined by concrete mortar</b> and back filling of the open space between the lining and the surrounding soil Ratio of cement Mortar = 1 cement :3 parts sand	Excavation 6 cubic meter circular Pit (diameter of 1500mm X 3400mm depth)	Cub. m	6		
	Remove the excavated soil 50 meters away from the construction site/location	Man day	8		
	Fired Bricks (60mm x 120mm x 2400mm)	Cub. m	3		
	Sand	Cub. m	2		
	Cement bag of 50 kg	Bags	3		
	Gravel	Cub. m	1.9		
	Back fill open space with 1.8 cubic meter gravel between lining and the surrounding soil (100mm x 5400mm x3400mm)	Man day	3		
	Semi Skilled Labor (2 assistant)	Man day	6		
	Skilled labor	Man-day	3		
	Total cost for pit lining with fired bricks				
Lining of unstable / sandy and clay soil, and for water logging areas with precast reinforced <b>concrete ring</b> and back filling of the open space between the lining and the surrounding soil Ratio of cement Mortar = 1 cement :3 parts sand	Excavation 3.8 cubic meter circular Pit (diameter of 1200mm x 3400mm depth)	Cub. m	3.8		
	Remove the excavated soil 50 meters away from the construction site/location	Man day	5		
	Precast reinforced blind concrete ring internal diameter 1000mm, thickness 100mm, and depth 500mm	Each	9		
	Stone	Cub. m	1		
	Sand	Cub. m	1		
	Cement bag of 50 kg	Bags	4		
	Gravel	Cub. m	1.9		
	Back fill open space with 1.92 cubic meter gravel between lining and the surrounding soil (100mm x 5650mm x 3400mm)	Man day	2		
	Semi Skilled Labor (2 assistants)	Man day	6		
	Skilled labor	Man-day	3		
Total cost for pit lining with precast reinforced concrete ring					

Pit lining material options	Description of materials and works	Unit	Quantity	Unit price	Total price
Lining of unstable / loose soil, with <b>wooden log</b> and back filling of the open space between the lining and the surrounding soil Ratio of cement Mortar = 1 cement :3 parts sand (for top 500mm depth)	Excavation 3.4 cubic meter circular Pit (diameter of 1300mm x 3400mm depth)	Cub. m	3.4		
	Remove the excavated soil 50 meters away from the construction site/location	Man-day	5		
	Wood log thickness 100mm diameter, each 4000mm long	Each	40		
	Wood log thickness 5cm diameter, each 5 meters long	Each	8		
	Nail of 8 grams	Gram	1,250		
	Stone	Cub. M	1		
	Sand	Cub. m	1		
	Cement bag of 50 Kg	Bag	2		
	Back fill open space with 1.4 cubic meter gravel between lining and the surrounding soil (100mm x 4000mm x 3400mm)	Man day	1		
	Semi Skilled Labor (2 assistants)	Man day	6		
	Skilled labor	Man-day	3		
	Total cost for pit lining with wooden log				
Lining of unstable / loose soil, with <b>bamboo</b> and back filling of the open space between the lining and the surrounding soil Ratio of cement Mortar = 1 cement :3 parts sand (for top 500mm depth)	Excavation 3.4 cubic meter circular Pit (diameter of 1200mm x 3400mm depth)	Cub. m	2.5		
	Remove the excavated soil 50 meters away from the construction site/location	Man-day	2		
	Bamboo stick/pole 30mm diameter thickness each 4 meters long	Each	25		
	Bamboo 30mm diameter thickness each 8 meters long	Each	210		
	Stone	Cub. m	1		
	Sand	Cub. m	1		
	Cement bag of 50 Kg	Bag	2		
	Semi Skilled Labor (2 assistant)	Man day	6		
	Skilled labor	Man-day	3		
	Total cost for pit lining with bamboo				

Pit lining material options	Description of materials and works	Unit	Quantity	Unit price	Total price
Lining top 500mm depth of the <b>stable soils with stone and concrete mortar</b> (no back filling) Ratio of cement Mortar = 1 cement :3 parts sand	Excavation 2.5 cubic meter circular Pit (diameter of 1000mm x 2.9m depth) + top 2m diameter with 500mm depth	Cub. m	2.5		
	Remove the excavated soil 50 meters away from the construction site/location	Man-day	2		
	Stone	Cub. m	1		
	Sand	Cub. m	0.5		
	Cement bag of 50 Kg	Bag	2		
	Semi Skilled Labor (2 assistant)	Man day	4		
	Skilled labor	Man-day	2		
	Total cost for pit top 500mm depth lining with stone and mortar				
Construction of <b>double vault dry compost latrine</b> wall with external thickness of 12cm and vault compartment wall thickness of 12cm basement thickness 10cm, – Internal volume = length 2.52m width 1.2m and depth 1.5m and – External volume = Length 2.76 width 1.44 x 1.6m depth – Volume of Bricks external wall and compartment thickness of 12mm and compartment = $6.63\text{m}^3 - 4.54\text{m}^3 = 1.82\text{m}^3$ cover slab (1.44m x 2,76m x 0.1 = 0.4m <sup>3</sup> Ratio of cement Mortar = 1 cement :3 parts sand	Excavation 6.36 cubic meter circular Pit (diameter of 1500mm * 3400mm depth)	Cub. m	6		
	Remove the excavated soil 50 meters away from the construction site/location	Man day	8		
	Fired Bricks size 24cm x 12cm x 6cm)- 67% total $1.82\text{m}^3 = 1.5\text{m}^3$	Each	870		
	Sand (for mortar and cover slab concrete work)	Cub. m	5		
	Cement bag of 50 kg (for mortar and cover slab concrete work)	Bags	5		
	Gravel	Cub. m	0.3		
	Reinforcement Iron bar diameter 8mm	Kg	21		
	wire	Kg	1		
	Semi Skilled Labor (2 assistant)	Man day	6		
	Skilled labor	Man-day	3		
	Total cost for pit lining with fired bricks				

## 5.3 Construction of Sub Structure

### 5.3.1 Latrine pit Excavation

#### General consideration before excavation:

- Understand characteristics of soil type
- Determine shape and external volume of the pit (consider type of lining material you are going to use)
- Determine depth of pit (consider ground water table)
- Determine whether to pit needs lining, if so whether it should be partial lined or the full depth of the pit should be lined
- Select and prepare suitable lining materials, if appropriate
- Select latrine location
- Locate /Adapt pit dimensions on the ground
- Excavate/dig the pit according to design (shape and dimension) to the required depth including top 500mm

#### If the soil type is loose (sandy, silt, clay or water logged)

- Dig pit depth equal to the height of the concrete ring/culvert (to prevent wall from caving in) and continue to dig the pit inside of the ring to the same depth, insert second ring/culvert, and continue in the same manner up to the desired depth.
- If the soil type is loose (Clay/Silt), dig a V-shaped pit (narrower bottom and wider top, (Figure 3) to eliminate chance of collapsing/caving in before starting lining works and start lining immediately - Dig the pit by sloping inward 100mm every 1000mm depth.

#### 5.3.1.1 Digging Stable and Loose Soil Formation

1. Determine latrine type, shape, size, volume and depth of the pit, and lining materials
  - > Once the latrine type (either dry or wet), shape (either circular or square), the volume of the pit, (for example, Figure 9 shows a circular pit with internal diameter of 1000mm with depth of 3m) and lining material (e.g. bricks, stone, concrete ring or wood) are determined, follow the following procedure to dig the pit.

**Figure 9:** Internal and external dimension of the latrine pit

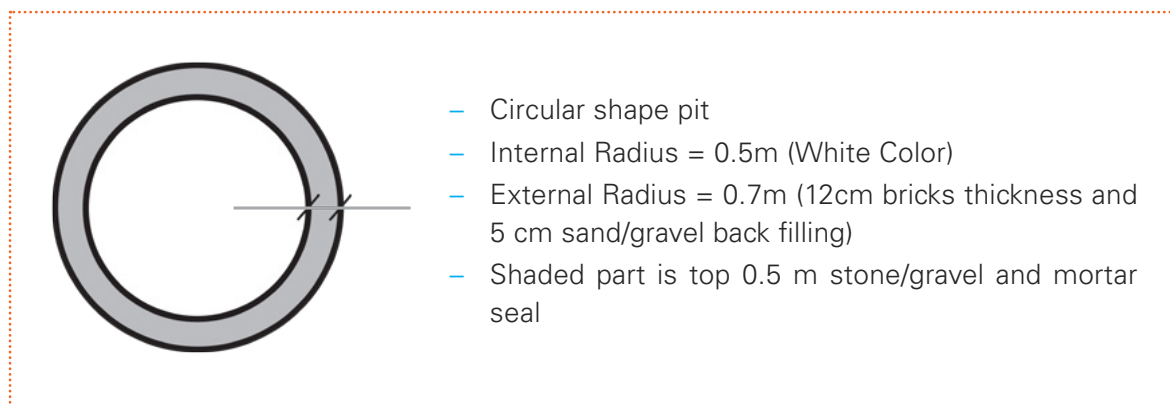

2. Make ready the required quantities of lining materials, such as bricks, sand, cement, gravel, stone, etc before starting digging of the pit

3. Select latrine building site and level the ground
4. Mark and post the stick firmly at the center point
5. Using rope or string measure a radius and make a circle around the firmly posted stick

**Example:**

If the lining material is fired bricks, add 0.12m (brick's thickness) and 0.05m (space for gravel/sand back filling) on the radius of the circular pit. This gives the external radius of the pit equals to 0.7m

6. First make a circle of internal diameter (white color) and then make a circle of external diameter (shaded portion). The shaded portion is for pit lining and space for gravel filling.
7. Sprinkle ash on the external diameter circle lines
8. Start digging the soil in to the marked circle area down up to 500mm irrespective of pit size
9. Before continuing digging, construct the ring beam using stone/bricks (top 500mm seal) by leaving the internal diameter open and adequately cure the ring beam for 7 days
10. Once the ring beam become dry continue to dig down wards to the desired depth (e.g. remaining 2500mm)
11. Dig the pit by sloping inward 100mm every 1000mm depth to avoid caving in of the pit wall (Figure 10)
12. Remove excavated soil away from the working area (2000mm away) from pit and immediately start lining work
13. Cure lining for 7 days and allow the mortar to dry completely before backfilling the space between the lining and ground with sand.

**Figure 10:** Narrow bottom inverted cone shaped latrine pit (Sketch)

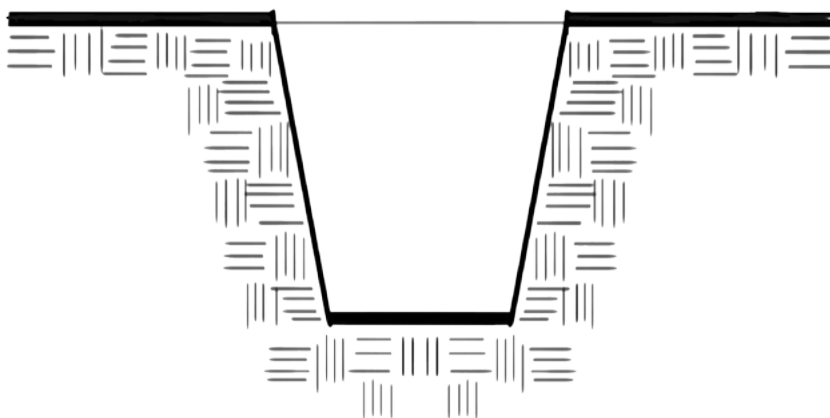

**V-shaped pit**

### 5.3.1.2 Digging Hard (Rocky) Soil Formation

Even though the deeper the pit is more advantageous to use the latrine for long time, sometimes it is difficult to dig in places where the water table is high or if there are rocky soil formation. Places where soil formation is rocky, it difficult to dig latrine pit to the required depth. In areas with rocky soil formation, the top surface soil layer of 500mm to 1 meter may be easily excavated and the remaining depth may be difficult excavate manually. Rocky and hard to dig soil is stable (pit does not collapse) and does not require lining, but sometimes it does not allow liquid part of the excreta to percolate (seep) into the surrounding ground and raw fecal matter may overflows and contaminate the environment (soil and surface water).

Therefore, in such areas it is important to consult local people to get the following information on;

- How did manage digging of such rocky soil (tactics, procedures, type of special digging materials)
- Maximum depth of the pit to bury deceased person and how long does it takes (time) to excavate the required depth, length and width, and how many persons involve.

Such information will help you to determine the pit dimension, and to decide on height of soil mounding above the ground, and associated costs.

1. If space is not a problem, excavate the pit to the maximum possible depth and increase width and length wise dimensions of the pit
2. If space is critical, after excavating the pit to the maximum possible depth, and continue to construct lining (stone, bricks or concrete ring) up to 1.2 meters above the ground (Figure 11).
3. Bring soil from other place construct mound around the pit structure and firmly compact the soil
4. Construct stage ways for the users
5. It is advisable to construct pit of the same dimensions (double vault) to alternately use the latrine and avoid re construction. Remove the superstructure; slab and vent from the old vault and install on new vault and seal top 500mm depth of old vault with soil and bio-degradable materials for more than 2 years.

**Figure 11:** Excavation of Rocky Soil Formation and Lining the Pit above the Ground (sketch)

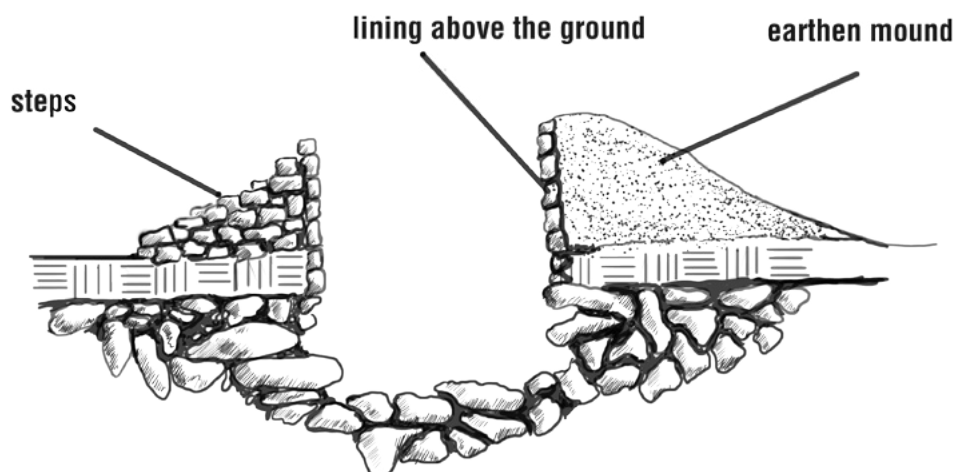

### 5.3.1.3. Digging Latrine Pit at Place with Highest Water Table and Flood prone area

Raised latrines are constructed in the areas of high water table and flood prone, where the recommended pit depths cannot be attained (Figure 12). In such circumstances the pit depths are increased by raising pit walls. The pit is excavated as deep as possible working at the end of dry season in areas of high ground water, provided that the water table of the particular area is known.

1. Collect information the type of soil, static water table during the dry season and height of water logging above the ground
2. Dig the pit to the required depth during dry seasons when the water table is lowest
3. Line the pit bottom and the whole wall with durable materials (fired bricks, stone or reinforced blind concrete ring) and make it water tight
4. Considering height of water logging above the ground level, extend lining above the ground level.

**Figure 12:** Excavation and Lining of Pit in areas of Highest Ground Water Table (Sketch)

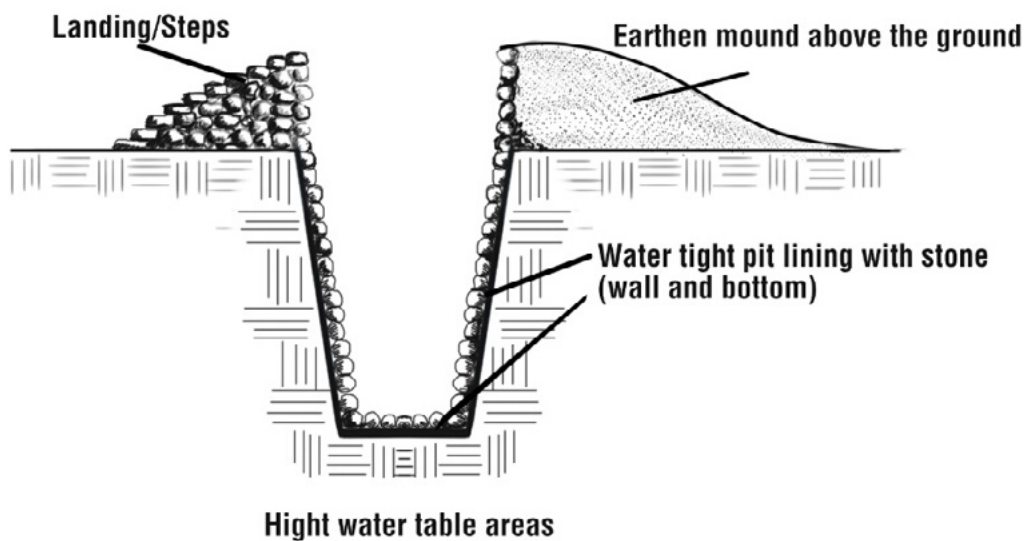

### 5.3.2. Pit Lining with Different Materials

The primary purpose of the lining is to prevent the pit wall collapsing and provide support to the slab, superstructure and guarantee safety for the users.

Lining with durable material makes it easier to remove fecal sludge when the pit becomes full and reuse the pit. Durable line materials are resilient and are able to withstand environmental pressures such as inundation, due to flooding and water logging.

- Even though the soil formation is hard and self supporting, the top 50 centimeter meters of the pit depth should be lined with durable materials and cement mortar joints to uphold (support) the slab and superstructure, to eliminate chance of caving in, and prevent entrance of runoff and vermin.



- Refill space between the soil and lining with gravel and sand. If the liquid part of the faecal sludge is intended to seep in to the surrounding soil, the pit lining should not be water tight (space between lining materials should not be closed with mortar).
- Do not forget curing of the lining and allowing time (7 days) for cement mortar to gain full strength.
- In marshy, water logged and flood prone areas, pre-casted reinforced concrete rings are resilient and is preferred for lining.
- Production of the latrine slab must be after completion of pit lining to allow at least a 100mm overlapping of the slab with the pit lining.
- If fecal matter is going to be removed from the pit (pit latrine and four flush off-set latrine), the cover slab should have a man-hole behind the superstructure through which hose can be inserted for vacuum emptying or enable complete removal of the slab to allow manual desludging.

#### 5.3.2.1 Pit Lining with Bricks/Stone

The decision to line with bricks or stone partially or fully depends on the stability of the soil in the area. If the wall of the pit is unstable, it will need to be fully lined. In general, prepare the required (selected) lining materials before digging the pit.

##### **Partial pit lining with bricks and stone**

1. Review the pit latrine design (sub structure, floor/slab, and the superstructure including, dimension, shape, and materials for construction)
2. Adapt the design on the ground/site and dig 500mm down from the ground level
3. Line the borders of the pit with permanent material (brick or stone).
4. Prepare mortar by mixing 1part cement in 3 parts clean sand (1:3 ratio), add water and mix thoroughly.
5. Use mortar to join the bricks/stone together, ensuring the bricks/stone are close together with very limited and there should not be space between bricks/stones. Use a spirit level to make sure the bricks/stone are even with each other.
6. Line to the top of the pit, the lining should go a little above the pit.
7. Cure adequately and allow the mortar to dry.
8. Dig the rest of the pit within the lining.

##### **Full Pit Lining with Bricks and Stone**

1. Review the pit latrine design (sub structure, floor/slab, and the superstructure including, dimension, shape, and materials for construction)
2. Dig the entire depth of the pit.
3. Level the bottom and clear away loose dirt and rocks.
4. Line the border of the pit with bricks/stone or wooden material (Figure 13).
5. Leave space between bricks/stone (seepage holes) by mortaring every other joint through which liquid part of the latrine content (sludge) seep in to the surrounding soil. But do not forget that the top 500mm should be completely sealed with mortar to avoid entrance of runoff and vermin.

6. If the lining is bricks or stone cure for at least 7 days and allow the mortar to dry completely before backfilling the space between the lining and ground with sand. The top 500mm of the pit should be backfilled with clay or mortar.

**Figure 13:** Pit lining with bricks



#### 5.3.2.2. Lining with Wooden and Bamboo Materials

1. Cut logs or wooden poles to a length equal to the depth of the pit.
2. Place the logs vertically along the sides of the pit. Space between the logs should be 25mm to 75mm
3. Cut four poles equal to the length and width of the pit (Figure 14).
4. Nail or tie the poles horizontally across the vertical logs. Do this about 500mm from the top, at the middle and at the bottom of the pit.
5. OR cut and post bamboo pole at 300mm. split bamboo lengthwise in to two or three pieces, and weave inside the pit. If the pit is circular, measure the external diameter and weave the bamboo outside and insert in to the pit (Figure 14)
6. Place/use a concrete ring beam on the top of the pit so as to make stable (to evenly distribute vertical pressure (load) of the slab on the lining

#### Note:

- In areas where bamboo trees are available like in the Benishangul, parts of Amhara and SNNP regions, woven bamboo can be used for pit lining materials.
- Wooden logs usually easily rot by damping or are damaged by termites. Therefore, first treat the logs with used motor oil to minimize rotting and damage by termite.

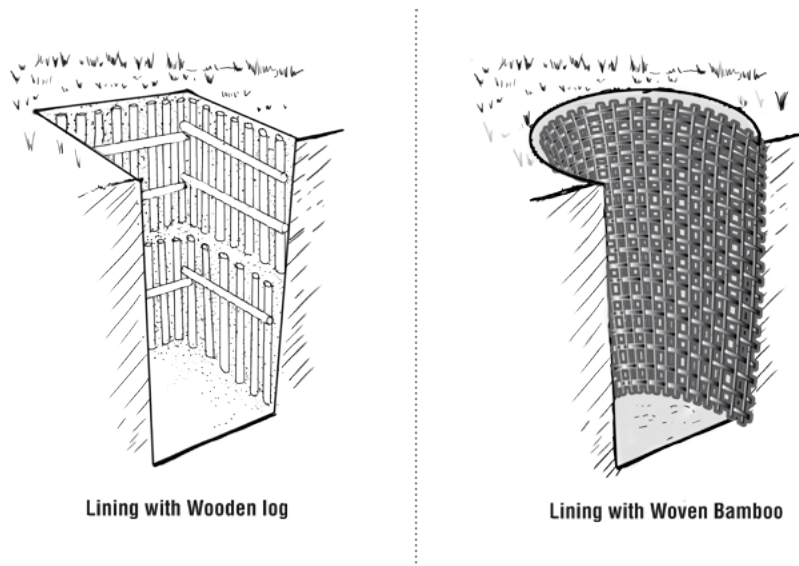
**Figure 14:** Wooden and bamboo materials for pit lining

#### 5.3.2.3 Lining with Ferrocemnet

To line full or partial depth of the pit with prepare mortar (mixture of sand and cement) and mesh wire (chicken wire) depending on the design of the latrine

Procedure for lining with ferrocemnet

1. Review the pit latrine design (sub structure, floor/slab, and the superstructure including, dimension, shape, and materials for construction). Check whether the pit is partially or fully lined.
2. If partially lining the pit, dig the pit 500mm down or if fully lining the pit, dig the entire depth of the pit.
3. Level the bottom and clear away any loose dirt and rocks.
4. Apply mortar to the walls of the pit; make a layer that is 12 mm thick.
5. Apply 2-3 layers of steel mesh wire (chicken wire).
6. You can keep the mesh in place by driving long staples through the mesh and mortar into the soil.
7. Below 500mm, put spacers in the mesh before it is covered with mortar. Use short pieces of 20mm diameter sticks inserted into mesh through the first layer of mortar.
8. Apply a second layer of mortar and push firmly into the mesh; the layer should be 10mm thick. The mesh should be completely covered with mortar.

#### 5.3.2.4 Lining with Precast Concrete Rings

1. Review the pit latrine design (sub-structure, slab, and the superstructure including, dimension, shape, and materials for construction). Check whether the pit is partially or fully lined with blind or perforated concrete rings or mixed.
2. If partially lining the pit, dig the top 500mm depth and insert a concrete ring inside the pit and then dig the rest of the pit inside the border of the ring.
3. If the pit is fully lined, dig the entire depth of the pit.

4. Level the bottom and clear away loose dirt and rocks.
5. Use/insert perforated rings at the bottom of the pit with holes between 25-50mm in diameter to allow seepage of the liquid parts of the latrine content in to the surrounding soil (Figure 15). If perforated concrete rings are not available, create hole between the joints of the rings by placing pieces of stone.
6. Seal joints together with mortar or cement.
7. Backfill behind the rings with sand.
8. If the highest ground water table reaches the ground surface, use water tight concrete rings, joints and bottom of the pit should be water tight.

**Figure 15:** Blind and perforated precast reinforced concrete rings



Precast reinforced concrete ring

#### 5.4 Construction and Installation of Latrine Slab

Once the construction of latrine substructure (excavation and lining) is completed, then construction of the pit slab is the next stage. The household can make choose and purchase slab that is compatible with the pit lining from the local market or produce the slab at on-site.

- It should adequately support the weight of the user and the superstructure components of the latrine.
- Slabs have different size and shape (rectangular, square or circular) and large size slabs are heavier slabs could cause damage to the pit lined by wooden or bamboo materials
- Thickness of the slab varies depending on the area of the pit
- There two types of concrete slabs:
  - > Concrete with no reinforcement bar (SanPlat)
  - > Reinforced concrete slab
- Slab has squat-hole with tight cover, but if the latrine is VIP does not need squat-hole cover
- The slab also has raised seat and hand rills for households with family members living with disability on their leg(s).
- VIP latrine has two holes (squat-hole and vent hole)
- The top surface of the slab should be intact (no opening) and smooth for easy cleaning and washing.

### 5.4.1 Slab Options

Choice of the latrine slab depends on the understanding of its functions, availability of different types, shape and size, easy to install, and its costs. The shape of slab could be circular, rectangular or square. Slab sizes also vary depending on the size of pit. It can also be produced from concrete (with and without reinforcement bar), plastic, or wooden materials.

Figures 16 to 21 provide important information on the type and shape slabs. Table 9 also provides basic description, advantages and disadvantages of different slab options to aid households and producers to make informed choice.

#### Types and shape of slab options

**Figure 16:** Reinforced square or rectangular concrete slab



Reinforced square or rectangular concrete slab

**Figure 17:** Reinforced circular concrete slab

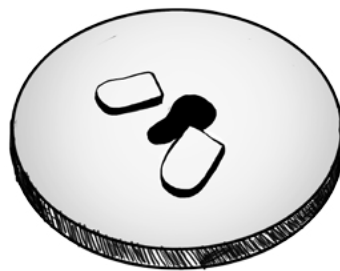

Reinforced circular concrete slab

**Figure 18:** SanPlat concrete slab



SanPlat concrete slab

**Figure 19:** Plastic slab

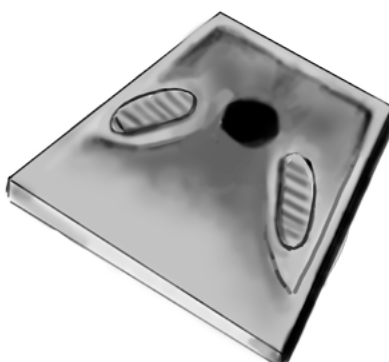

Plastic slab

**Figure 20:** Wooden Slab (riprap)

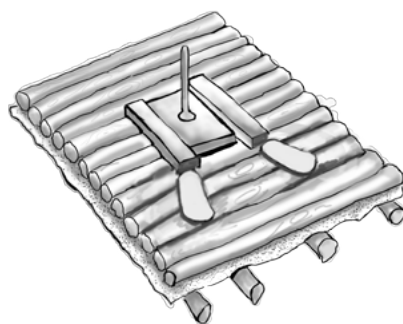

Wooden Slab (riprap)

**Figure 21:** Wooden slab (timber)

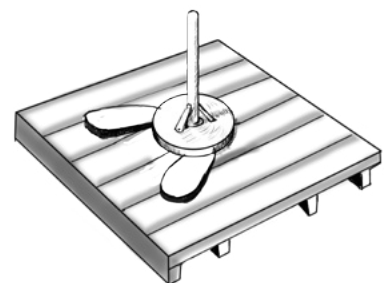

Wooden slab (timber)

**Note: Important consideration while choosing slab options**

- Primary consider size of the pit including slab-lining overlap (10 - 15cm)
- Consider availability/access to construction materials and skilled person for construction and/or for installation of the slab
- Costs of the slab (purchase or production, transportation and installation costs)
- Slab options could be ready made or produced on-site
  - > Plastic slab, toilet pan and concrete slab of different size and shape can be directly purchased from the local market,
  - > Reinforced concrete slab and wooden slab is usually produced on-site or purchased from the local producers/sellers.

In addition, choice of slab options shall consider design and type of latrine intended to be built by the household.

- In densely populated areas where households may not have spare land to dig new latrine, double vault (twin pit) compost latrine is suitable compared to other options. Therefore, transferable type of slab is preferred to the permanent type. But, the slab should be divided in to two or three pieces to easily uninstall and transfer to the new pit.
- Using transferable slab has an advantage for the household. it is reused and no need to buy other slab for new pit when the first pit become full and makes pit emptying easier.
- On the other hand, if households have access to water for toilet flashing, permanent slab fitted with ceramic or plastic pan with water seal (trap) is preferred to transferable slab. Because faeces and urine are drained to alternate soak pit. However, the soak pit should be covered by removable (transferrable) slab.

Furthermore, transporting Concrete Slab should be taken in to consideration while planning for slab construction. The following note provides information on how to solve concrete slab transportation challenges.

**Note:**

Concrete slabs are heavy to transport from production or selling sites to site of installation. The household may transport using human labor, animals back or cart pulled by animals. Therefore, for easily carrying, loading and unloading and transportation, it is very important to divide the slab in to two to three pieces during production.

- Prepare wooden straight and smooth timber splints of different length
- Paint the timber with used motor oil
- Place the timber splint at equal distance from one end to other end in the formwork (mould) before pouring the concrete - section 5.5.1 –step 2
- If you want to divide the slab in to two equal pieces, measure and place the splint at center, but if you want to divide the slab in to three pieces, measure place two splints at equal distance.
- Measure and cut (length and width wise) for each pieces and place the reinforcement bar in the formwork (mould) – section 5.5.1- step 5
- Pour concrete in to the formwork (mould)- section 5.5.1 -step 5
- Do the same activities under section 5.5.1 step 6,
- Smoothen the top surfaces of each piece of the slab and edges of the squat-hole, but scratch and leave rough top surface of the slab where foot rest will be set during installation.
- Allow the concrete to set for one hour and then remove the splint (s) slowly and do not smoothen the edges
- Adjoin pieces of one slab together during installation using cement mortar
- Set the foot rest on the scratched surface of the slab

**Figure 25:** Concrete slab divided in to two pieces

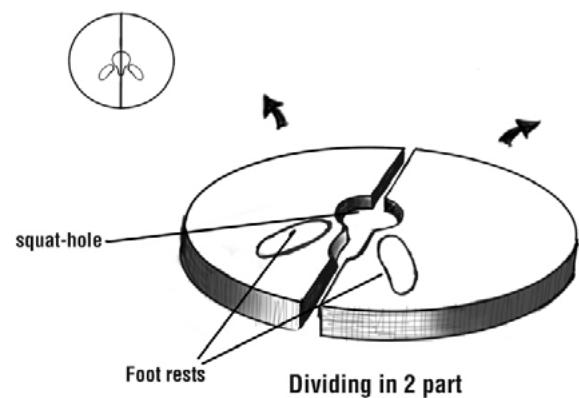

**Figure 26:** Concrete slab divided in to three pieces

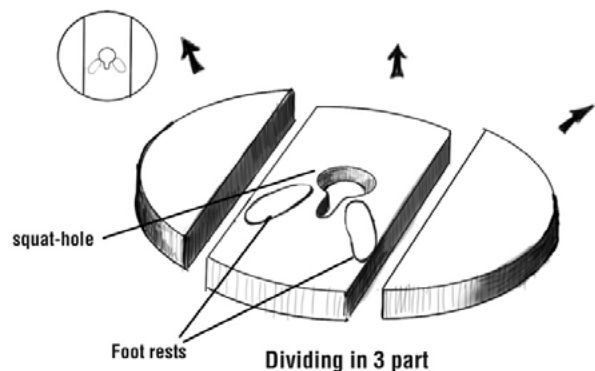

**Table 10:** Description, advantages and disadvantages of latrine slab options

Slab Options	Slab size (Example)	Description	Construction skill	Advantage	Limitations
<b>Wooden Slab</b>	1100mm x 1100mm x 100mm	Wood riprap or timber supported by wooden logs placed over the top of the pit. Riprap should be mud plastered to allow easy cleaning and fill opening between the ripraps	The owner or local carpenters can build the wooden slab	<ul style="list-style-type: none"> <li>- Constructed with locally available construction materials</li> <li>- Lighter compared to concrete slab and can be install over pit lined by any type of material (either with wood, bamboo, bricks, stone, or ferrocemnet)</li> <li>- Low cost compared to all other slabs</li> </ul>	<ul style="list-style-type: none"> <li>- Not washable but cleanable</li> <li>- Damaged by decomposition and termites if not treated with used motor oil</li> <li>- Not suitable in areas wood logs are not available</li> <li>- Not environmentally friendly (Deforestation)</li> </ul>
<b>SanPlat</b>	600mm x 600mm x 600mm	SanPlat concrete slab is small size concrete slab produced with no reinforcement bar, it is supported by wooden slab (riprap)	<ul style="list-style-type: none"> <li>- Can be locally produced and installed by local mason and carpenters with some skill training</li> <li>- Placed on the wooden slab</li> </ul>	<ul style="list-style-type: none"> <li>- Durable, safe, Reusable and washable</li> <li>- Easily transported</li> <li>- Easily cleaned</li> <li>- Lighter compared to reinforced concrete slab and can be install over pit lined by any type of material (either with wood, bamboo, bricks, stone, or ferrocemnet)</li> </ul>	Wooden slab (support) could be damaged by decomposition and termites
<b>Rectangular, square or circular reinforced concrete Slab</b>		It is precast concrete slab reinforced with iron bar. Thickness of the slab increase as size increases. Large diameter iron bar is used as the size of slab increase.	Produced by local masons with adequate skill training	<ul style="list-style-type: none"> <li>- Durable, safe, and Reusable</li> <li>- Washable and easily cleaned</li> <li>- Suitable to install over the pit lined either with wood log, bricks, stone or ferrocemnet</li> <li>- It is also possible to install over pit dug in stable soil with top 50 cm gravel and mortar seal</li> </ul>	<ul style="list-style-type: none"> <li>- It collapses if placed over the pit lined with bamboo</li> <li>- Relatively high cost</li> </ul>
<b>Circular Dome-Shaped Concrete Slab</b>		It is precast concrete slab without reinforcement	Produced by local masons with adequate skill training	<ul style="list-style-type: none"> <li>- Durable, safe, and Reusable</li> <li>- Washable and easily cleaned</li> <li>- Suitable to install over the pit lined either with bricks, stone</li> <li>- It is also possible to install over pit dug in stable soil with top 50 cm gravel and mortar seal</li> </ul>	<ul style="list-style-type: none"> <li>- It collapses if installed over the pit lined with bamboo</li> <li>- Relatively high cost</li> </ul>
<b>Plastic Slab</b>		It is product of industrial product manufactured from polyethylene vinyl chloride (PVC)	Installed by local masons and carpenters with minimum skill training	<ul style="list-style-type: none"> <li>- Durable, safe, and Reusable</li> <li>- No rusting /corrosion problem</li> <li>- Washable and easily cleanable</li> <li>- Suitable to install over the pit lined with any type of lining materials</li> <li>- Relatively low cost compared to reinforced concrete slab</li> </ul>	Not widely available in the local market and need promotion



#### 5.4.2 Determine Shape and Size of the Slab

The shape and size of the latrine slab is determined based on the shape and size of the pit and thickness of the lining. The size of slab should be slightly wider to provide adequate overlapping of at least 10 cm with the thickness of pit lining. Therefore, the slab could be a circular flat or dome-shaped, rectangular or square shaped.

The shape and size of the slab to be produced on site or purchased from the local market should be compatible and linked to the shape and size of the pit lining (Table 11).

- If the shape of the pit is circular, the slab shape should be circular to tightly cover the pit and the same for square and rectangular pits
- Type and Size (diameter, length and width, and thickness) of the slab should consider type of the pit lining
- If pit lining is not durable material (stone, bricks or reinforced concrete ring), do not use reinforced concrete slab to prevent collapsing of latrine and danger to the user. Instead, use lighter slabs (like wooden and plastic slabs)
- Wider pit size needs larger and thicker size slabs reinforced by thicker iron bar and narrow space between the reinforcement bars.
- The slab size should overlap 100mm to 150mm (10-15 cm) with pit lining on all sides

**Table 11:** Linkage between pit and slab shape and size

Pit shape	Lined Pit size	Type and shape of Slab product	Slab size	Remarks
Circular pit	Internal free space diameter of 1200mm (1m)	Reinforced Concrete Circular slab	Diameter of 1500mm (1.50m)	<ul style="list-style-type: none"> <li>– 150mm (15 cm) overlap with pit lining</li> <li>– Slab split in to three pieces</li> <li>– Re-bar diameter of 12mm and inter-bar space 15cm</li> <li>– Slab Thickness of 100mm (10cm)</li> </ul>
	Internal free space diameter of 1100mm (1m)		Diameter of 1400mm (1.40m)	<ul style="list-style-type: none"> <li>– 150mm (15 cm) overlap with pit lining</li> <li>– Slab split in to three pieces</li> <li>– Re-bar diameter of 12mm and inter-bar space 15cm</li> <li>– Slab Thickness of 100mm (10cm)</li> </ul>
	Internal free space diameter of 1000mm (1m)		Diameter of 1300mm (1.30m)	<ul style="list-style-type: none"> <li>– 150mm (15 cm) overlap with pit lining</li> <li>– Slab split in to two pieces</li> <li>– Re-bar diameter of 10mm and inter-bar space 10cm</li> <li>– Slab Thickness of 80mm (8cm)</li> </ul>
	Internal free space diameter of 900mm (90cm)		Diameter of 1200mm (1.20m)	<ul style="list-style-type: none"> <li>– 150mm (15 cm) overlap with pit lining</li> <li>– Re-bar diameter of 10mm and inter-bar space 12cm</li> <li>– Slab Thickness of 100mm (10cm)</li> </ul>
	Internal free space diameter of 800mm (80cm)		Diameter of 1100mm (1.10m)	<ul style="list-style-type: none"> <li>– 150mm (15 cm) overlap with pit lining</li> <li>– Re-bar diameter of 10mm and inter-bar space 12cm</li> <li>– Slab Thickness of 100mm (10cm)</li> <li>– Pit diameter less than 80cm does not allow excavation</li> </ul>

Pit shape	Lined Pit size	Type and shape of Slab product	Slab size	Remarks		
<b>Rectangular pit</b>	Internal free space Area 1000mm x 1200mm	Reinforced Concrete Rectangular slab	1300mm x 1500mm (1.30m x 1.50m)	150mm (15 cm) overlap with pit lining		
	Internal Area free space Area 900mm x 1100mm			Slab split in to three pieces		
				Re-bar diameter of 12mm and inter-bar space 15cm		
<b>Square pit</b>	Internal free space Area 800mm x 1000mm	SanPlat with no reinforcement	700mm x 700mm (0.7m x 0.7m)	Slab Thickness of 100mm (10cm)		
	Internal free space Area 800mm x 1000mm			Slab split in to two pieces		
				Re-bar diameter of 10mm and inter-bar space 12cm		
<b>Square pit</b>	Internal free space Area 1200mm x 1200mm	Reinforced Square concrete slab	1500mm x 1500mm (1.50m x 1.50m)	Pit with less than 80cm width does not allow excavation		
	Internal free space Area 1100 mm x 1100 mm			Placed over the wooden log/riprap		
				Internal free space Area 1000 mm x 1000 mm	Slab thickness 60mm (6cm)	
	Internal free space Area 900 mm x 900 mm				Can be installed on Arborloo latrine	
				Internal free space Area 800 mm x 800 mm	Placed over the wooden log/riprap	
	Internal free space Area 800 mm x 800 mm				Slab thickness 60mm (6cm)	
				Internal free space Area 800 mm x 800 mm	Can be installed on Arborloo latrine	
	Internal free space Area 1200mm x 1200mm				Reinforced Square concrete slab	1500mm x 1500mm (1.50m x 1.50m)
				Slab split in to three pieces		
	Internal free space Area 1100 mm x 1100 mm			Reinforced Square concrete slab	1400mm x 1400mm (1.40m x 1.40m)	Re-bar diameter of 12mm and inter-bar space 15cm
						Slab Thickness of 100mm (10cm)
	Internal free space Area 1000 mm x 1000 mm			Reinforced Square concrete slab	1300mm x 1300mm (1.30m x 1.30m)	150mm (15 cm) overlap with pit lining
Slab split in to two pieces						
Internal free space Area 900 mm x 900 mm	Reinforced Square concrete slab	1200mm x 1200mm (1.20m x 1.20m)	Re-bar diameter of 12mm and inter-bar space 15cm			
			Slab Thickness of 100mm (10cm)			
Internal free space Area 800 mm x 800 mm	Reinforced Square concrete slab	1100mm x 1100mm (1.10m x 1.10m)	150mm (15 cm) overlap with pit lining			
			Slab split in to two pieces			
Internal free space Area 800 mm x 800 mm	Reinforced Square concrete slab	1100mm x 1100mm (1.10m x 1.10m)	Re-bar diameter of 12mm and inter-bar space 15cm			
			Slab Thickness of 100mm (10cm)			

Pit shape	Lined Pit size	Type and shape of Slab product	Slab size	Remarks
<b>Rectangular</b>	Internal free space Area 800 mm x 900 mm	Plastic slab	700mm x 800mm	<ul style="list-style-type: none"> <li>- Placed over the wooden log/riprap</li> <li>- Smooth top surface and ragged bottom</li> <li>- Outer sides of the slab (length and width wise) is sealed by precast concrete beam and mortar</li> </ul>
<b>Square</b>	Internal free space Area 800 mm x 800 mm		700mm x 700mm	<ul style="list-style-type: none"> <li>- Placed over the wooden log/riprap</li> <li>- Smooth top surface and ragged bottom</li> <li>- Outer sides of the slab (length and width wise) is sealed by precast concrete beam and mortar</li> </ul>
<b>Rectangular or square</b>	Toilet cubicle with floor Area range from 0.8m <sup>2</sup> to 1m <sup>2</sup>	Plastic /Ceramic Pan with water seal/trap	588mm x 468mm	<ul style="list-style-type: none"> <li>- Set up in to concrete slab/floor</li> <li>- Can be fitted to on-set and off-set pour flush latrine</li> <li>- Height of 291 mm</li> <li>- Connected to water seal/trap and drainage pipe</li> </ul>
			520mm x 400mm	<ul style="list-style-type: none"> <li>- Set up in to concrete slab/floor</li> <li>- Can be fitted to on-set and off-set pour flush latrine</li> <li>- Height of 190mm</li> <li>- Connected to water seal/trap and drainage pipe</li> </ul>

#### 5.4.3 Determining Quantities and Cost of Slab Options

Quantities of material for slab construction and corresponding costs vary depending on the size of the slab and type of construction materials. Durable slabs (like reinforced concrete slabs and plastic slab) are relatively costly compared to wooden slab. But wooden slabs, though low cost, can be damaged by termites or by decaying. In addition, they are not washable or cleanable. Production, purchase and installation costs of different slab options vary from region to region and Woreda to Woreda depending on availability of materials, skills, and skilled labor in the area.

Information about cost of the slab production materials is important to choice among different slab options at affordable cost. Table 12 provides information on the specification of quantities of material, purchase of the materials or slab and labor (unskilled and skilled) required for the production and installation. Quantities materials for slab production are calculated based on the following basic assumptions.

**Table 12:** Bill of quantities for construction of different square shape latrine slabs

Slab type	Slab Size (Example)	Description of items	Unit	Quantity	Unit price	Total price
<b>Circular reinforced concrete slab with diameter of 1.3m and thickness 100mm, split in to two pieces</b> Concrete aggregate Ratio: Cement: Sand: Gravel = 1:2:3, and Ratio of cement Mortar = 1 cement :3 parts sand	Diameter 1300mm and Thickness 100mm	Cement bag	Kg	15		
		Sand	Cub. M	0.09		
		Gravel	Cub. M	0.013		
		Reinforcement bar diameter of 10mm	Kg	18		
		Wire	G	250		
		Vent pipe of 75 or 110mm diameter, 2.5 m long	Each	1		
		Mesh with size less than 20mm	Sq. m	0.5		
		Water	L			
		Unskilled labor (construction and installation)	Man-day	2		
		Skilled labor (construction and installation)	Man-day	1		
		Total Cost				
<b>Reinforced concrete slab</b> Concrete aggregate Ratio: Cement: Sand: Gravel = 1:2:3, and Ratio of cement Mortar = 1 cement : 3 parts sand	1000mm x 1000mm x thickness 80mm	Cement bag	Kg	15		
		Sand	Cub. M	0.09		
		Gravel	Cub. M	0.013		
		Reinforcement bar diameter of 8mm	Kg	7		
		wire	G	200		
		Vent pipe of 75 or 110mm diameter, 2.5 m long	Each	1		
		Mesh with size less than 20mm	Sq.m	0.5		
		Used motor oil	L	1		
		Straight, smooth and clean Wooden frame (formwork) of 1030mm x 100mm x 20mm thickness for preparation of mould (slab, foot rest and squat-hole)				
		Nails (# 5 and 6)	G	0.5		
		Used oil	L	1		
		Water	L			
		Unskilled labor (construction, curing and installation)	Man-day	2		
		Skilled labor (construction and installation)	Man-day	2		
		Total Cost				

Slab type	Slab Size (Example)	Description of items	Unit	Quantity	Unit price	Total price
<b>Concrete SanPlat slab (with no reinforcement)</b>  Concrete aggregate Ratio: Cement: Sand: Gravel = 1:2:3, and Ratio of cement Mortar = 1 cement : 3 parts sand	600mm x 600mm x 60mm	Cement bag	Kg	10		
		Sand	Cub. m	0.06		
		Gravel	Cub. m	0.09		
		Vent pipe of 75mm or 110mm diameter, 2.5m long	Each	1		
		Mesh with size less than 20mm	Sq.m	0.5		
		Used motor oil	L	1		
		Straight, smooth and clean Wooden frame (formwork) of 1030mm x 100mm x 20mm thickness for preparation of mould (slab, foot rest and squat-hole)				
		Nails (# 5 and 6)	G	0.5		
		Used oil	L	1		
		Water	L			
		Unskilled labor (construction, curing and installation)	Man-day	2		
		Skilled labor (construction and installation)	Man-day	2		
		Total Cost of SanPlat				
<b>Wooden slab</b>	1100mm x 1100mm x 100mm	Wood log thickness 100mm diameter each 1.3 meters long	Each	6		
		Wooden log thickness 6cn diameter each 1 m long	Each	17		
		Nails # 8 and 9	Kg	1		
		Used oil	L	5		
		PVC Vent pipe 75mm or 110 mm diameter 2.m long	Each	1		
		Mesh wire of size less than 20mm	Sq.m	0.5		
		wire	M	3		
		Unskilled labor (construction and installation)	Man-day	2		
		Skilled labor (construction and installation)	Man-day	2		
Total cost of wooden slab						

Slab type	Slab Size (Example)	Description of items	Unit	Quantity	Unit price	Total price		
Purchase and installation of plastic slab	700mm x 700mm x 80mm	Plastic slab ragged at its bottom with squat-hole cover, eight openings for nailing or screwing (2 on 4 sides)	Each	1				
		Nail #8, 9 and 10	Gram	1000				
		Wood log 1000mm diameter each 1.2m long	Each	4				
		Reinforcement bar 8mm diameter	M	10				
		Cement	Kg	0.23				
		Sand	Kg	0.05				
		Gravel	Kg	24				
		Unskilled labor (construction and installation)	Man-day	1.5				
		Skilled labor (construction and installation)	Man-day	1.5				
		Total cost of purchasing and installation of the plastic slab						
Purchase of Ceramic/plastic pan and installation/ setting of ceramic/ plastic pan into concrete floor/slab	Size 588mm x 468mm x 291mm Size: 520mm x 400mm x 190mm	Plastic pan in ceramic Pan with integrated S-trap, seamless finish, smooth surface, back outlet, for floor or slab mounting and easy fitting, with accessories and installation manual		1				
		Drain PVC Pipe of 110mm diameter of 6m long	Pcs	1				
		Fired bricks for construction of diversion Chamber of 400mm x 400mm x 400mm and setting of pan into the concrete floor/slab	Each	35				
		Cement for construction of diversion Chamber of 400mm x 400mm x 400mm and setting of pan into the concrete floor/slab	Kg	15				
		Sand for construction of diversion Chamber of 400mm x 400mm x 400mm and setting of pan into the concrete floor/slab	Kg	50				
		Unskilled labor (construction and installation)	Man-day	1				
		Skilled labor (construction and installation)	Man-day	1				
				Total cost for purchasing and installation or setting of plastic or ceramic pan into the concrete floor/slab				

## 5.5 Step by Step Guidance for Construction of Concrete Slab

### 5.5.1 Construction of the Reinforced Concrete Slab

Despite differences in size and shape, construction of reinforced concrete slab follows the same procedures and has seven important steps. Under each steps sequential instructions are described. In addition, some precautionary notes are also provided. The seven steps include;

1. Prepare Slab construction working area and materials
2. Construct Wooden, metal or fiber Frame (formwork)
3. Place Reinforcement bar
4. Mix Concrete
5. Pour the Concrete
6. Finish the Concrete Slab
7. Cure the Concrete Slab
8. Adding Features to a Slab Used by People with Disabilities (optional)

To show step by step procedure, construction of slab size of 1000mm X 1000mm X 80mm is taken as an example.

#### **Step 1:** Prepare Slab construction working area and materials

The area where the slab will be constructed should be level and free of organic materials such as leaves, animal feces and debris. Clean and spread sand over the working area. It is advised that place for construction of slab should be under shade to avoid direct sun heat and to maintain slow drying of the slab.

#### **Step 2:** Construct wooden frame (formwork)

- Leveling the ground working space (site) for placement of moulds, and for concrete preparation of concrete. The working site should be under shed (not exposed to direct sun light or rain)
- First assemble the internal and external slab moulds, moulds of squat-hole and grease the inner surface of the mould with used motor oil that comes in contact with concrete

#### **Step 3:** Place the reinforcement bar

For example; if it is planned to construct a 1000mm x 1000mm slab with thickness of 80mm, Use reinforcement bar of 8mm diameter

- Cut the reinforcement bar each 995mm long.
- Place reinforcement bar every 120mm (space between bars) on length and width wise direction
- Tie each intersection with wire
- Measure 28 cm inward to the center in all sides and cut central 2 bars
- Place the reinforced grid bar in the slab frame (Figure 22)
- Put rock/stone under the grid at the 4 edges and center to raise up from the floor
- Paint the squat-hole mould with motor oil and place the squat-hole mould (wider edge at the back 28 cm from slab edge inward and narrow edge at front).
- Place foot rest mould rear edge at the two third length of squat-hole mould (235mm) and lay both foot rest mould 45 degree outwards left and right
- Leave circular space of diameter 115mm for vent pipe at the rear side of the slab

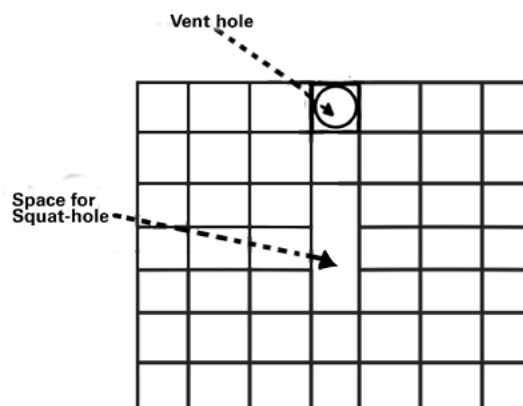
**Figure 22:** Reinforcement bar laid in the formwork (mould)**Step 4:** Mix the Concrete

Concrete is a mixture of cement, sand, gravel and water.

1. Check that the slab frame (formwork) is properly placed, the squat-hole and vent pipe moulds are in place before mixing the concrete
2. Treat the squat-hole mould with motor oil before placing
3. Use the same unit of measure (bucket) to measure cement, sand and gravel in to one pile.
4. Proportion of amount of Cement: Sand: Gravel = 1C : 2S : 3G. This means; first measure using the same bucket
  - > 1 part (bucket) cement
  - > 2 parts (bucket) sand (lean and free of silt or soil)
  - > 3 parts (bucket) gravel size of less than 20mm diameter
5. Properly mix the cement, sand, and gravel together on a clean surface until it completely combined and continue mixing evenly until all of the aggregate (gravel and sand) is covered with cement
6. Then create hole by opening space in the middle of mixed concrete and add water and mix again and again.
7. Slowly add water, mixing as you go and never let water to flow outwards
8. Concrete should have soft consistency, moist, dough (i.e., not too stiff or not too runny)
9. Concrete needs to be the right consistency.

**Note:**

- If concrete mixture is too dry it will cure too quickly and slab cracking and breaking happens. If concrete mixture is too wet, may form pockets of water which will also weaken/cracking on the structure of slab.
- If dirt and organic materials are accidentally mixed, it weakens the concrete mixture/structure
- Use clean sand and gravel (free of dirt, clay, silt and organic matter)
- Take care not to mix with soil materials
- Use best grade cement (of good quality)



**Step 5:** Pour the Concrete – in to the slab formwork (mould)

1. Pour concrete continuously starting at one edge of the slab and working it through the rest of the slab. Avoid pouring in separate piles.

**Note:**

- **Concrete should not be dumped in separate piles and then leveled and worked together; nor should the concrete be deposited in large piles and moved horizontally into final position**

2. Once concrete is distributed throughout the slab, vibrate the concrete using a wooden float to get rid air bubbles, and fill the concrete until it reaches top edge of the slab
3. Screed top surface of the concrete using a wooden board slowly
4. Move excess concrete and level around the squat-hole by using the float

**Step 6:** Finish the Concrete slab

1. Smooth the top concrete surface with a wooden float.
2. Use the float to work the gravel/stones into the slab and allow the sand and cement to come to the surface. Apply pressure and vibration to the concrete. This will eliminate air pockets that could reduce the durability/strength of the slab.
3. Test whether the concrete is firm or not by pushing down your finger up to 1 cm depth and smoothen the surface and rough edge using a float.
4. Finish the sides of the slab by using a trowel or edging tool
5. Remove any sharp edges or ridges from top surface of the slab by lightly dragging the edge of a metal trowel along the surface in a sweeping motion.
6. Set the foot rests (align the foot rest moulds with the squatting hole, scratch the surface of concrete slab inside the mould with edge of metal trowel where foot rest will be set, and gradually place the concrete in to the foot rest moulds)
7. Repeat steps 1-3
8. First allow concrete to set for about an hour. Then, remove the footrest frames (moulds).
9. Continue toweling the surface until the concrete shines
10. Cast the Squat-Hole and smoothen the edges

Smooth the edge of squat-hole to make cleaning easier and to tightly fix hole-cover

11. Before the concrete is set, gently hit the squat-hole mould with a hammer to reduce air bubbles
12. When the concrete is firm to the touch, remove the squat-hole mould
13. Moisten a cement bag with water and gently smoothen the edges of the squat-hole.
14. Remove any sharp or protruding sand and gravel materials.
15. Continuously repeat this process until squat-hole edges is smooth and free of sharp edges.

**Step 7: Cure the Concrete slab**

Curing is keeping the slab moist and under a shed for at least week and beyond until it attains full strength. Proper curing of concrete slab for more than seven days ensures its strength and durability. Keeping slab moist allows the slab dry slowly. If slab dries too fast, it may crack and finally breaks.

1. Water should not be added within the first 8-10 hours (initial setting after casting) because concrete itself has water
2. Start to cure (sprinkle water on the exposed surface of the slab) after 10 hours, at least twice a day for 10-14 days (final setting)
3. Keep the slab wet /moist by placing wet straw or wet cloth directly over the surface of the slab.
4. Remove the formwork (frame) after 7days and move the slab after 14 days
5. Keep the slab at the same place under a shed for 14 days and do not install before 28 days (before complete hardening)

**Note:**

- Sprinkle water on the concrete slab at least once per day for seven days
- Keep the slab under the shade for about one month (to ensure its full strength)
- Do not use previously opened cement bag, stored too long, and that formed hard mass

**Addressing needs of family members with physical disabilities**

There households living with family member who have problems on their leg (s) and use wheel chair or arm support for walking. Thus, there should be special arrangement/modifications on the features of the slab and sufficient size of the person uses wheel chair.

**Adding Features to a Slab Used by People with Disabilities**

## Adding Handrails

- Add or embed strong handrails (usually galvanized iron pipe with diameter of 30mm) in to the reinforced concrete slab to support the weight of the user when they are sitting or squatting and when they stand up after defecation (Figure 23).
- Fix or weld the handrails with reinforcement bar
- Consult user (elderly or family member who have disability about distance between handrails and their height before fixing (welding).
- If wooden handrails are used, it should be strongly fixed on the wall

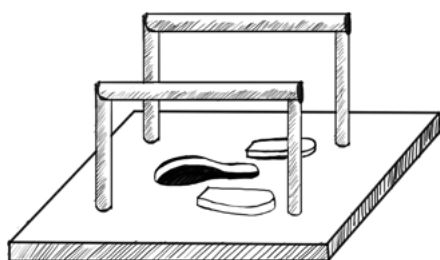
**Figure 23:** Galvanized iron pipe Handrails

Galvanized iron pipe Handrails

### Raised Toilet Seat and Ramp

- People whose both legs are not functioning may due to paralysis or accident usually use wheel chair to move from place to place or crawl using hand and body parts.
- To easily access latrine for such people, latrine seat should be raised (sitting) type. Sitting type of latrine pan is convenient for people with disabilities to transfer from wheel chair to the seat and for elder people to lower themselves.
- Raised latrine can easily constructed from wood (like chair) with handrails (Figure 24a)
- Fix the legs of the chair on the concrete slab
- Construct ramp with slope of 20% for family members using wheel chair to easily access to the latrine (Figure 24b)

**Figure 24a:** Raised wooden latrine seat

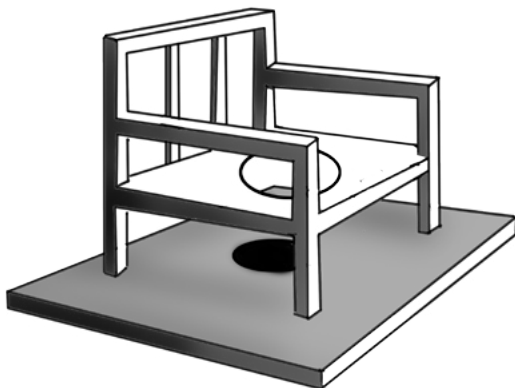

**Raised wooden latrine seat**

**Figure 24b:** Ramp

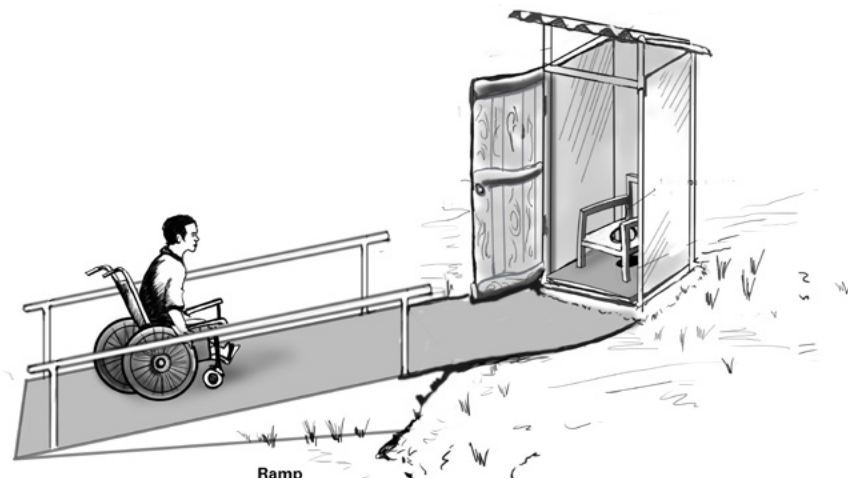

**Ramp**

#### 5.5.2. Construction of Sanitary Platform (SanPlat)

A SanPlat is the concrete slabs size of 600mm x 600mm x80mm without reinforcement bars. Such type of slab gives alternative for households who cannot able to buy reinforced concrete slab. Constructing the SanPlat applies the same principles, procedures and materials with exception of using reinforcement bar.

### 5.5.3. Construction of Wooden Slab

The top part of the wooden slab can be mud plastered to create a flat floor for easy cleaning. SanPlat slab or plastic slab can be placed on the wooden slab.

Construction of the wooden slabs follows four steps

1. Measure and cut woods
2. Treat wood
3. Construct slab
4. Plaster the floor with mud mixed with cement
5. Construct four reinforced concrete ring beams (to place 2 lengths and 2 widths wise) for prevention of termite access to wooden riprap

#### Step 1: Measure and cut the wood

For example: to construct wooden slab with internal size of a 1000mm x 1000mm;

1. Measure pieces of strong wood to fit over the latrine pit, with an overhang of 400mm on each side. (length of the overhang should be 400mm from one end and 400mm on another end to eliminate chance of collapse and ensure safety for the user). Then, total length of the wood will be  $1000\text{mm} + 400\text{mm} + 400\text{mm} = 1800\text{mm}$ . Flat wooden slab is easier to construct and clean than the round wooden slab.
2. Measure 300mm from the back wall and create a rectangular squat-hole with length 330mm X width 180mm center to the front wall (90mm from the left and 90mm from the right side). Measure and cut pieces of the riprap wood to fit to dimensions of the squat-hole and place/fix on the supporting wood.
3. Measure six pieces of wood for the lateral support (4 lateral supports and 2 middle supports each with length of 1800mm to be laid to support the shortened pieces of woods cut to create squat-hole).
4. Cut the pieces of wood at the appropriate lengths.

**Figure 27:** Picture of a carpenter measuring and cutting the wood

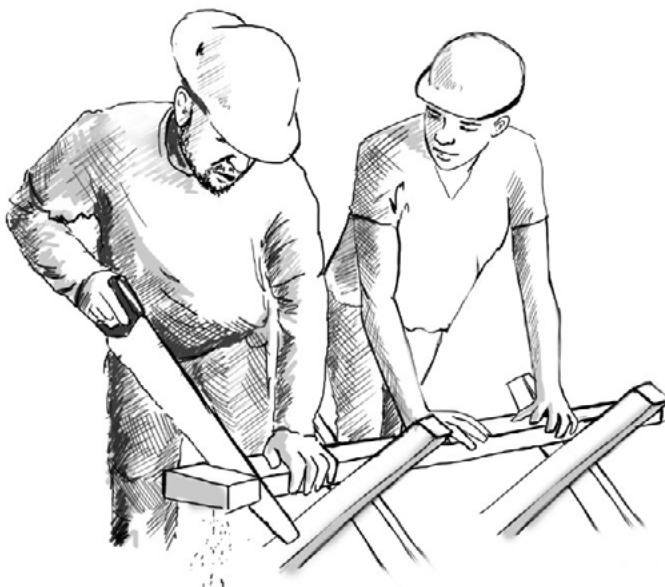

**Step 2:** Treat the wood

1. To prevent termite treat wood with used motor oil or paint. Spreading ash or lime on places where the wood rests before placing the later and middle wooden supports, or wraps the wood with plastic materials to prevent termite and rotting.
2. Before installing the slab allow the used oil to dry.

**Figure 28:** Picture of a person painting (treating) the wood

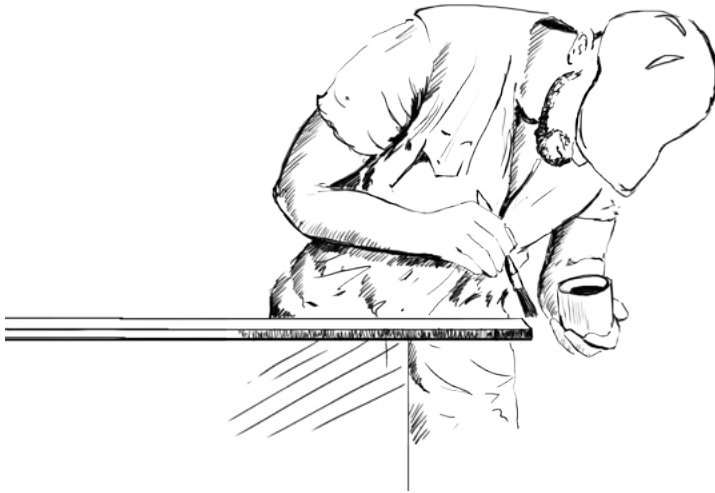
**Step 3:** Lay the wooden slab

1. Lay pieces of wood, approximately a meter long, parallel to each other. This will create the top of the slab.
3. The shorter pieces of wood should be placed in the middle of the slab to create a squatting hole.
4. Place the four lateral supports horizontally across the slab, two on each side of the squatting hole in opposite direction to the wooden slab (riprap). Fix firmly the lateral and middle support wood to the concrete beam.
5. Nail firmly each riprap wood to the lateral and middle supporting wood

**Figure 29:** Picture of a carpenter nailing riprap to the lateral supporting pieces of wood



**Step 4:** Plastering the wooden slab with mud

1. Mix mud and grass or straw and spread on slab to create a thick, flat layer. Plastering helps to close openings between riprap, prevent fly egress, make cleaning easy and stability while using.
6. Do not step on the plastered slab before the mud dries and become hard
7. Add cement to mud to hardened floor surface. If cement is not available, use soil from termite mound which is hard and water proof.

**Figure 30:** Picture of a person plastering the wooden slab**Note: Termite prevalence, use of wooden slab and preventive measures**

- Termite is common challenge in rift valley, low land and western parts of Ethiopia.
- It causes damage to structures build by wooden materials (house, latrine, fence and food stores) and pose direct and indirect economic and environmental impact
- Wooden slabs are susceptible and easily damaged by termites. Wooden slabs are not preferred to other slab options, unless households cannot afford or other options are not available in the area
- If no other option, treat (paint) the wooden materials used for construction of slab and superstructure with used motor oil and/or wrap with plastic materials
- Destruct termite-mound (nest) by excavation, flooding and/or suffocation by mobilizing the community

**5.6 Installation of Slabs****5.6.1. Installation of Concrete Slabs**

- Installation of SanPlat and reinforced concrete slab is done after the slab is fully dried and attained it full strength (i.e. after 28 days).
  - The top 500mm depth around the top of the pit should be constructed by the strong material (stone or brick with concrete mortar) to support the weight of slab. Otherwise, as the slab is heavier (weigh above 80 Kg), it may damage the lining of the pit.
  - Therefore, do not install reinforced concrete slab on substructure lined with weak materials (like wood and bamboo).
1. Place the slab on the top surface of the pit lining
  2. The slab surface should overlap with pit lining at least 100mm in all sides, and

3. Seal openings between the bottom surface the slab and the lining using concrete mortar. For example, Figures 31 and 32 show foundation constructed from bricks to support the circular and rectangular reinforced concrete slab.

### Slab Foundation (top 500mm depth)

**Figure 31:** Circular Foundation

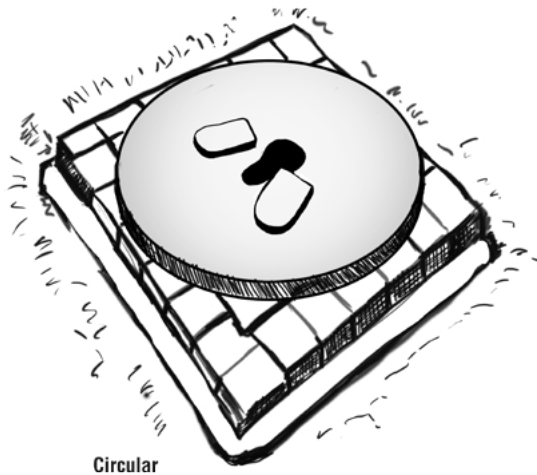

**Figure 32:** Rectangular Foundation



4. Construct superstructure (see section 5.7)
5. Seal any opening with concrete mortar at the juncture of slab, wall, and top surface of the pit lining
6. Clean top surface of the slab to remove any hard materials for easy cleaning and washing

#### 5.6.2. Installation of Plastic Slabs

Once the pit lining is completed and ready for installation of the plastic slab, for example on a pit with internal size of 1000mm x 1000mm

1. While constructing pit lining, leave spaces (2 on each of 4 sides) where wooden log of 120mm diameter (slab support) will be placed.
2. Prepare 4 wood logs each 1200mm long and treat with used motor oil to prevent rotting
3. Measure, cut and place wooden logs (2 on width and 2 on length wise) on the designated space on the top of pit lining. Measuring is important because to fit points where plastic slab is screwed or nailed on the top side of the wood logs on each four sides.
4. If the size of the plastic slab does not fit with the internal size of pit, prepare 4 pieces of reinforced concrete beam of 1200mm x 100mm x 80mm (thickness) to cover the outer opening surrounding the plastic slabs
5. Place and fix the wood logs together at crossing points with nails
6. Place and fix the precast concrete beams with concrete mortar
7. Remove un even top surface of the pit lining (surfaces and edges where plastic slab rests) or make smooth by using cement mortar
8. Place the plastic slab and fix the slab with the wooden logs on each sides using nails or screw.

9. Build the superstructure (see section 5.7)
10. Seal any opening between the plastic slab and concrete beams with cement mortar
11. Level top surface of the concrete beam and surface of plastic slab at equal and make smooth with cement mortar,
12. Finally clean top surface of the slab from any rough materials

### 5.6.3. Installation or Setting of Plastic or Ceramic Pan into a Concrete Slab

Most of the times, toilet pan suppliers sell the pan with installation manual. In addition, the finished top of the slab and top of the toilet pan should be on equal level (Figures 33 and 34). Therefore, sufficient space must be arranged ahead while constructing the concrete slab by measuring dimensions (length, width and depth) of the squatting pan and additional space for installation of the S-trap or P-Trap and leave sufficient space in the slab.

1. Remove stone or cement stone from the open space where the pan to be set
2. Place bricks under the trap to hold the pan and place the pan on the bricks in the slab level
3. Connect S-Trap or P-Trap to drain hole of the pan on one end and to drain pipe on other end
4. Check water sealing by adding water and whether water gently flow through drainage pipe (slope) to the soak away pit.
5. Check whether top of the pan is equal to the level of the finished slab (by using spirit level)
6. Fill a void space beneath the pan with concrete cement (mortar) as well as space between the slab and the pan in all sides, and void space beneath and around the S-Trap
7. Check again the level and correct any deviations
8. Immobilize the pan and S-trap until it becomes stable
9. Gently clean or remove using sponge or wet cloth any rough things (like ruminants of mortar), sand or cement powder on the surface of the squatting pan and in the hole before it dries.
10. Cure the mortar for at least 7 days

**Figure 33 and 34:** Toilet pan set in to the floor or slab

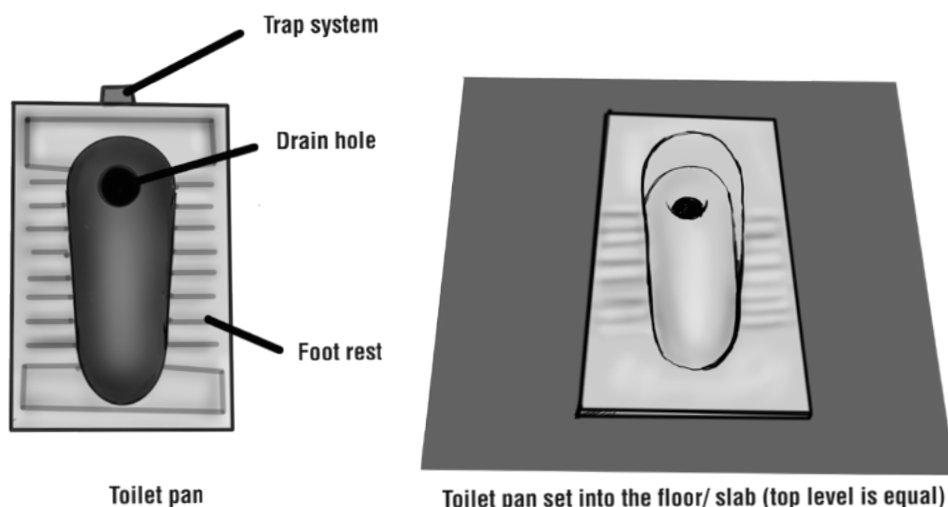



## 5.7 Construction of Latrine Superstructure

- Latrine superstructure is the part above the ground and includes wall, door and roofing.
- The superstructure prevents the pit from filling with runoff water and wooden slab from decaying.
- It also protects the user from sun and rain, and provides privacy during defecation. Good superstructure also provides security for women.
- The latrine cubicle should have enough space to provide comfort to user (not less than 0.9m<sup>2</sup>) and adequate walling and roofing.

### 5.7.1. Latrine Walling and Roofing Options

- The design of latrine superstructure and materials used for its construction varies from place to place depending on the culture, livelihood, and availability of construction materials.
- The selection of walling and roofing materials should consider strength of the pit lining materials and prevalence of termites. Lighter materials like wood, bamboo, CIS, canvas and grass are advisable.
- In areas where lighter materials are not available or not affordable, heavy materials like mud blocks, bricks and stone can be used, but wall structure should be built outside of the slab and the pit lining.
- Materials for construction of superstructure (walling and roofing) could be permanent or transferable and depends on the preference of the household, availability of the material and skills to construct the latrine, and associated costs.
- Similar to dwelling house, wood, stone, grass, leaves, mud bricks, corrugated iron sheet and polyethylene plastic sheet are commonly used material options for construction of latrine wall and roofing (Figures 35-40).

### 5.7.2 Determine Quantities and Costs of the Latrine Walling and Roofing Materials Options

- Bricks and Corrugated Iron Sheets (CIS) walling materials are relatively costly compared to other walling material options. Materials like stone may not be available in some communities and polyethylene plastic sheet is also may not be available in the market some remote rural areas. However, households can use the same materials used for walling and roofing construction of dwelling house.
- Similar to materials used for construction of pit lining and slabs, costs of walling and roofing materials vary from region to region and Woreda to Woreda and from time to time depending on availability of materials and skilled labor in the area.
- Tables 13A and 13B provide information for the households and entrepreneurs on walling material options and corresponding advantages and disadvantages so as to make their choice by taking in to consideration associated costs. Similarly, Tables 13C and 13D provide the same information on roofing material options.

### Types and shape of slab options

**Figure 35:** Stone-mud wall (movable wall)

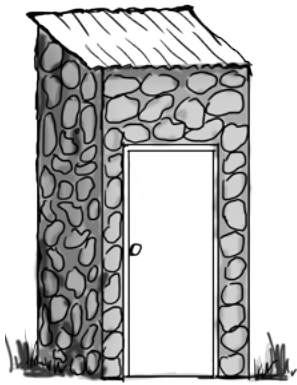

**Figure 36:** Bricks wall (permanent wall)

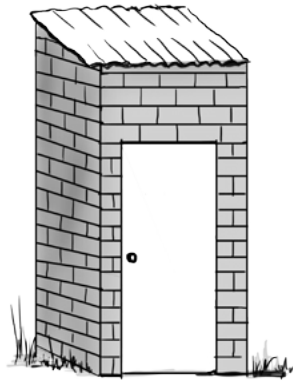

**Figure 37:** CIS wall and roof (movable wall)

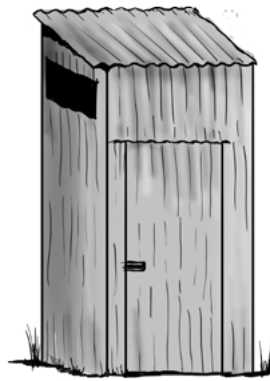

**Figure 38:** Wooden wall with CIS roof

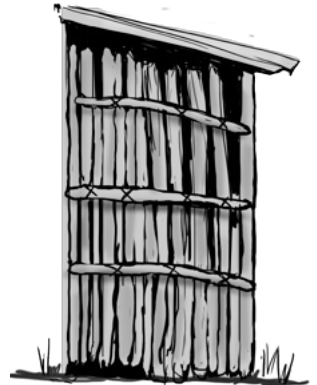

**Figure 39:** Mud plastered wooden wall/thatched roof



**Figure 40:** Grass/leaf wall and roofing



**Table 13A:** Latrine walling Material options and their corresponding advantages and disadvantages

Walling materials	Description	Advantage	Disadvantage
<b>Woven bamboo</b>	Is prepared by vertically splitting bamboo in to two or three parts and woven in the bamboo poles firmly posted in the ground and equally spaced between the posts	<ul style="list-style-type: none"> <li>- Provides privacy</li> <li>- Termite tolerant than wood</li> <li>- Does not need special skill and can be built by the owner</li> <li>- Does not need mud plastering</li> <li>- Can be built on wooden and concrete slabs and pit lined by any type of materials</li> </ul>	<ul style="list-style-type: none"> <li>- Not widely available all over the country</li> <li>- Affected by termites</li> <li>- Households may prioritize bamboo for production of marketable materials like basket, chair, and floor matting, etc</li> </ul>
<b>Wood log</b>	Can be harvested from the forest or grown on land plots Commonly used for construction of walling of the dwelling house	<ul style="list-style-type: none"> <li>- Widely available</li> <li>- Provides privacy and protection from wind</li> <li>- Relatively low cost</li> <li>- If mud plastered, it provides privacy</li> <li>- It does not need special skill and can be built by the owner</li> <li>- Can be built on any type of slab and pit lined by any type of materials</li> </ul>	<ul style="list-style-type: none"> <li>- Easily rot and damaged by termites if not treated by used oil (not durable)</li> <li>- Deforestation</li> <li>- Wood is scarce and costly in some parts of the country</li> </ul>
<b>Mud blocks</b>	Made from mixture of soil and hay and sun drying Used for walling of house in areas where wood is scarce or not affordable	<ul style="list-style-type: none"> <li>- Provides privacy and protection from wind</li> <li>- Tolerates termite damage and relatively durable than wood</li> <li>- Can be produced with minimum skill training,</li> <li>- Low cost compared to bricks, stone and concrete block</li> <li>- Can be used for construction of off-set type of latrines</li> <li>- Can be built on the concrete slab reinforced by bar diameter of 12mm and pit lined by stone, precast reinforced concrete rings, or fired bricks</li> </ul>	<ul style="list-style-type: none"> <li>- Heavy weight and cause collapse to wooden and plastic slab and pit lined with wooden, ferroemnet materials</li> <li>- Easily damaged by vermin (rodents)</li> <li>- If no proper roofing, it easily damaged by rain and collapse</li> </ul>

Walling materials	Description	Advantage	Disadvantage
<b>Bricks (fired or sun dried)</b>	Prepared from soil and made dry by sun heat or by firing traditionally to make it strong. Usually produced for household use and commercial purposes	<ul style="list-style-type: none"> <li>- Provides privacy and protection from wind</li> <li>- Raw material (soil) is widely available</li> <li>- Each household can produce bricks with some skill training</li> <li>- Termite resistant and not decompose like wooden materials</li> <li>- Not damaged by rodents/vermin</li> <li>- Bricks can be reused if the pit is full and changed</li> </ul>	<ul style="list-style-type: none"> <li>- Heavy weight and cause collapse to wooden and plastic slab and to pit lined with wooden, ferrocemnet materials</li> <li>- It requires concrete mortar</li> <li>- Mortar needs 7 days curing and less feasible areas where water is scarce</li> <li>- Requires skilled labor</li> <li>- Relatively costly</li> </ul>
<b>Masonry Stone</b>	Stone is locally used for construction of fence and dwelling houses. Some households use stone dike around wooden wall for flood prevention. produced and manually crushed for household use and small businesses	<ul style="list-style-type: none"> <li>- Provides privacy and protection from wind</li> <li>- stone is not damaged by termite and rodents/vermin</li> <li>- It can be built by local skill using mud mortar</li> <li>- Stone is widely available in most parts of the country</li> <li>- Widely used for construction of houses and latrines in highland areas where hard to get wood</li> <li>- Can be used for construction of wall for off-set latrine</li> </ul>	<ul style="list-style-type: none"> <li>- Heavy weight and cause collapse to all types of slab and pit lining</li> <li>- if mortar is used, it needs 7 days curing and less feasible in areas here water is scarce</li> <li>- Relatively costly</li> </ul>
<b>Concrete hollow blocks</b>	can be locally produced but not commonly used by large majority of rural households	<ul style="list-style-type: none"> <li>- Provides privacy and protection from wind</li> <li>- durable – and not damaged by moisture, termites and rodents</li> <li>- Can be built on reinforced concrete slab and pit lined with bricks and stone or reinforced concrete ring</li> </ul>	<ul style="list-style-type: none"> <li>- not reusable once the pit is full</li> <li>- requires skilled labor</li> <li>- needs mortar and curing for 7 days</li> <li>- cost is very high compared to others</li> </ul>
<b>Corrugated iron sheet (CIS)</b>	CIS is commercial product mainly used for roofing in rural areas	<ul style="list-style-type: none"> <li>- Provides privacy and protection from wind</li> <li>- Durable and not damaged by termites and rodents</li> <li>- Material is reusable (transferrable to other new latrine)</li> <li>- Can be constructed by the local carpenters</li> </ul>	<ul style="list-style-type: none"> <li>- Damaged by corrosion (rusting)</li> <li>- Heat up under the sun and increases temperature inside the pit and production of offensive odor</li> <li>- Difficult to construct in the absence of wooden frame</li> </ul>

**Table 13B:** Walling Material Options and cost estimation

Walling Material Options	Wall Size (Example; length 1200mm x with 1200mm and rear height 1700mm)	Description of items	Unit	Quantity	Unit price	Total Price
<b>Thatched wall</b>	1200mm x 1200mm x 1700mm	Wood log diameter of 100mm each 2.5m long	Each	6		
		Wood 50mm diameter each 1.30m long	Each	16		
		Wood 5mm diameter each 1.65m for rafter	Each	4		
		Nail #6 & #7	Gram	1000		
		Grass for wall cover	Bundle	4		
		Unskilled labor	Man-day	1		
		Skilled labor	Man-day	1		
		Total Cost of thatched wall				
<b>Woven bamboo or mesh supported by Bamboo/ wooden pole</b>	1200mm x 1200mm x 1700mm	Wood log diameter of 100mm each 2.5m long	Each	6		
		Bamboo 30mm diameter each 2m long	Each	80		
		Bamboo mesh with area 2m x 4.8m for wall cover,	Each	1		
		Wood 5mm diameter each 1.25m for wall frame	Each	6		
		Nail #6 & #7	Gram	500		
		Unskilled labor	Man-day	1		
		Skilled labor	Man-day	1		
		Total Cost of bamboo walling				
<b>Polyethylene plastic sheet/ canvas supported by wooden pole</b>	1200mm x 1200mm x 1700mm	Wood log diameter of 100mm each 2.5m long	Each	6		
		Wood 5mm diameter each 1.25m for wall frame	Each	6		
		Polyethylene Plastic Sheet (canvas) With Area 2m x 4.8m for wall cover,	Each	1		
		Nail #6 & #7	Gram	500		
		Unskilled labor	Man day	½		
		Skilled labor	Man day	½		
				Total Cost of polyethylene plastic sheet/canvas walling		

Walling Material Options	Wall Size (Example; length 1200mm x with 1200mm and rear height 1700mm)	Description of items	Unit	Quantity	Unit price	Total Price
<b>Corrugated iron sheet (CIS) wall supported by wooden pole</b>	1200mm x 1200mm x 1700mm	Wood log diameter of 100mm each 2.5m long (6),	Each	6		
		Wood 50mm diameter each 1.3m long (6),	Each	6		
		Wood 5mm diameter each 1.25m for wall frame (6),	Each	6		
		Nail #6 & #7 with hut (500 gram),	Gram	500		
		Corrugated iron Sheet (CIS), 35-G for walling	Each	6		
		Unskilled labor	Man-day	1 ½		
		Skilled labor (carpenter)	Man-day	1 ½		
		Total Cost of CIS walling				
<b>Wooden logs</b>	1200mm x 1200mm x 1700mm	Wood log diameter of 100mm each 2.5m long	Each	6		
		Wood 50mm diameter each 2.30m long	Each	30		
		For walling, wood 5mm diameter each 1.65m for rafter (4),	Each	4		
		Nail #6 & #7 (2000 gram),	Gram	2000		
		4 bundles of teff-hay for wall mud plastering	Bundle	4		
		Mesh wire with less than 2mm opening	Sq. m	0.25		
		Unskilled labor	Man-day	3		
		Skilled labor	Man-day	3		
		Total Cost of wooden walling				
<b>Dry Masonry stone wall with mud mortar</b>	1200mm x 1200mm x 1700mm	Masonry stone mortared by mud	Cub. M	4.5		
		Unskilled labor for preparation of mud mortar and assist skilled builder	Man-day	6		
		Skilled labor (stone building)	Man-day	6		
		Total Cost of masonry stone wall				

**Table 13C:** Latrine Roofing Material options and their corresponding advantages and disadvantages

Roofing materials	Description	Advantage	Disadvantage
<b>Thatched /grass/leaves</b>	<ul style="list-style-type: none"> <li>Commonly used for roofing of dwelling house, crop storage, and latrines.</li> <li>In some areas used for construction of house and latrine walls</li> </ul>	<ul style="list-style-type: none"> <li>Provides protection from rain, wind and sun</li> <li>Widely available roofing material</li> <li>Very low cost (affordable)</li> <li>Can be constructed using local skills and by the household</li> <li>Inside latrine is cooler and prevents high temperature inside the latrine and less odor emission</li> </ul>	<ul style="list-style-type: none"> <li>Damaged by termites, earth worms, and rodents</li> <li>Prone to fire accident</li> <li>Requires wooden materials support (impossible to use in areas where wood is scarce)</li> <li>Weight of the thatched roof increases during rainy season</li> <li>Not fully prevent rain and could be damaged by rain</li> </ul>
<b>Bamboo strips (mesh)</b>	<ul style="list-style-type: none"> <li>Produced by splitting bamboo in to tiny parts and woven cross over each other. Meshed bamboo is commonly used roofing, for floor mat and bedding in areas where bamboo is prevailing</li> </ul>	<ul style="list-style-type: none"> <li>Can be crafted locally and available in the local market</li> <li>Bamboo type of grass that can easily grow in the compound if the ecology is conducive.</li> <li>Can serve for three to five years</li> <li>Can be built by local carpenters and/or by the household</li> <li>Reduces sun heat, prevents wind</li> <li>Relatively low cost</li> </ul>	<ul style="list-style-type: none"> <li>Easily damaged by decomposition (due to rain) and by termites and rodents</li> <li>Not fully prevent rain (dripping)</li> </ul>
<b>Polyethylene Plastic sheet</b>	<ul style="list-style-type: none"> <li>Is commercial material Commonly used roofing materials in pastoral and households in low land communities</li> </ul>	<ul style="list-style-type: none"> <li>Provides protection from rain, wind and sun</li> <li>Lighter than CIS and Thatched roofing materials</li> <li>Easy to construct – not require special skills</li> <li>Relatively low cost compared to CIS</li> </ul>	<ul style="list-style-type: none"> <li>Heat up under the sun and increases temperature inside the pit and production of offensive odor</li> <li>Easily damaged by sun heat and rodents</li> </ul>
<b>Corrugated Iron sheet (CIS)</b>		<ul style="list-style-type: none"> <li>Provides protection from rain, wind and sun</li> <li>Durable and reusable (can be transferred to new latrine</li> <li>Relatively costly at initial but, can be low cost when its durability is considered</li> </ul>	<ul style="list-style-type: none"> <li>Heat up under the sun and increases temperature inside the pit and production of offensive odor</li> <li>High initial cost but, affordable for well to do households</li> </ul>

**Table 13D:** Roofing Material Options and cost estimation

Roofing material Options	Roofing size (Example: length x Width)	Description of items	Unit	Quantity	Unit price	Total price
<b>Thatched (Grass)</b>	1500mm x 2000mm	Wood 50mm diameter each length 2.2m	Each	6		
		Wood 30mm diameter each length 5m	Each	5		
		Grass for roof cover	Bundle	5		
		Rope 0.5mm thickness	meter	50		
		Unskilled labor	Man-day	1		
		Skilled labor	Man-day	1		
		Total Thatched roofing cost				
<b>Bamboo mesh</b>	1500mm x 2000mm	Bamboo Mesh Dimension (length 1.5m x 2m)	Each	1		
		Wood 50mm diameter each length 2.2m	Each	6		
		Wood 30mm diameter each length 5m	Each	5		
		Rope 0.5mm thickness	meter	50		
		Unskilled labor	Man-day	1		
		Skilled labor	Man-day	1		
		Total cost of Bamboo mesh roofing				
<b>Polyethylene plastic sheet/ canvas</b>	1500mm x 2000mm	Polyethylene Plastic sheet /Canvas Dimension (length 1.5m2m)	Each	1		
		Wood 50mm diameter each length 2.2m	Each	6		
		Wood 30mm diameter each length 5m	Each	5		
		Rope 0.5mm thickness	meter	50		
		Unskilled labor	Man-day	1		
		Skilled labor	Man-day	1		
		Total cost of polyethylene plastic sheet/Canvas roofing				
<b>Corrugated Iron Sheet (CIS)</b>	1500mm x 2000mm	Corrugated Iron Sheet (CIS) , 35-G	Each	2		
		Wood 50mm diameter each length 2.2m	Each	3		
		Wood 30mm diameter each length 5m	Gram	500		
		Nail #7	meter	50		
		Unskilled labor	Man-day	1		
		Skilled labor	Man-day	1		
		Total cost of CIS roofing				



### 5.7.3 Construction of the Latrine Walling, Roofing and installation of Vent Pipe

- Making ready required walling and roofing materials, if not built by the household, communicate and agree with labor workers
- The overall weights of the latrine superstructure (wall and roofing) directly rest on the slab and pit lining or outside of the slab.
- Shape of the latrine superstructure could be similar with shape of the slab (either circular, rectangular or square).
- The front height of the wall should not be less than 2 meters.
- Door should have inside lock for security and wire screen made of mesh wire with opening (weave size) less than 2mm opening.
- Install screen made up of mesh wire with size 500mm x 250mm on one side of the latrine wall above the door and roofing

#### 5.7.3.1 Construction of Latrine Wall and Roof

For example, to construct a wall around slab with assize of 1000mm x 1000mm; the external size (length and width wise) of the wall will be 1200mm x 1200mm including thickness of the wall built by wooden material. If the wall is built with other durable materials (like stone and bricks), and wall thickness decreases if it is built by polyethylene and bamboo materials.

- Measure and cut two wood logs equally to a length of 2.2m (1.7m above the ground and 50cm posted in the ground).
- Measure and cut and another two wood logs equally to a length of 2.7m (2.2m above the ground and 50cm posted in the ground)
- Measure the wall length and with wise (1.2m x 1.2m) around the slab and mark the four corners
- Dig the pit to the depth of 50 cm
- Post the wooden poles side by side at the four coroners (shorter poles at the back and longer at the front) and fix to the ground by compacting the soil (to immobilize)
- Cut 12 wood log of 5cm diameter thickness each at 1.25m length and connect the four poles with nails at equal length (at bottom, middle (1.33m) and top at height of 1.7m) and connect in the same way the two long pole at the top 2.2m. From the door side, poles are connected at the bottom and at the top.
- Cover the wall by selected material, (either by CIS, grass, bamboo or polyethylene plastic sheet)
- Prepare door from CIS, woven bamboo or polyethylene plastic sheet and fix on the wall

#### 5.7.3.2 Installation of Vent Pipe

- Cut bamboo or PVC vent at a length of 50 cm above the highest roof pick
- Vertically insert the vent pipe in the hole on the slab that leads down the pipe in to the pit.
- Seal opening around vent and attach to slab by concrete mortar
- If vent pipe is erected outside of the wall attach the vent pipe to wall using wire or rope and if it is erected inside of the wall the vent should pass through the roof
- Seal openings around the juncture of the vent pipe and slab and roof opening through which vent pipe is passed using cement mortar
- Tie screen (mesh wire) on the top of the vent pipe

**Note**

- Bad odor or smell that is produced inside the pit can be removed through vent pipe top opening covered with mesh-wire cape.
- Length of the vent-pipe should protrude (extend) 500mm above the highest pick of the roof.
- Vent pipe can be produced locally from hollow bamboo, or by connecting plastic bottles or PVC vent pipes of different diameter (75mm and 110mm) are also available in local markets.

**5.7.3.3 Preparation and Installation of the Wire Mesh Screen on the Latrine Wall**

If the wall is built from mud plastered wooden, bricks, or blocks; prepare and set screen made from mesh wire on the wall for illumination inside of the wall (Figure 41)

1. Cut the wire mesh at the length of 500mm and width of 250mm (Area = 500mmX 250mm)
2. Prepare a wooden frame and the set the screen on the frame with # 4 nails
3. Set the screen on the wooden wall with nails
4. If the wall is made of bricks, block or stone, the mesh screen does not need wooden frame, and set it on the wall with concrete mortar before plastering the wall
5. After finishing plastering work, paint the mesh wire with anti-rust

**Figure 41:** Wall screen (made of wire mesh)

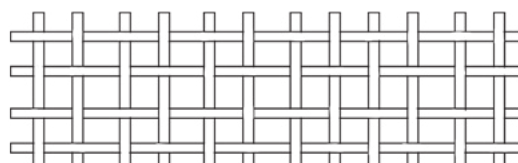

Wire Mesh Screen Opening: 2mm x 2mm (without wooden frame)

- Mesh Screen Area = 500mm x 250mm



Wire Mesh Screen Opening: 2mm x 2mm (with wooden frame)

- Mesh Screen Area = 500mm x 250mm
- Wooden Frame Length Wide = 500mm x 30mm x 20mm
- Wooden Frame Width Wide = 250mm x 30mm x 20mm

**5.7.3.2 Construction of Rectangular or Square Roofing**

- Cut three wood logs with diameter of 7cm thickness at a length 1.9 meter (rafter) and fix on horizontal top ties between the long and short poles at equal distance
- Cut three wooden logs with diameter of 5cm thickness at a length of 1.7m (purlin) and fix on the rafter at equal distance of the rafter
- Cover the roof by selected material, (either by CIS, grass, or polyethylene plastic sheet)

**Figure 42:** Sketch of latrine wall, roofing and vent pipe

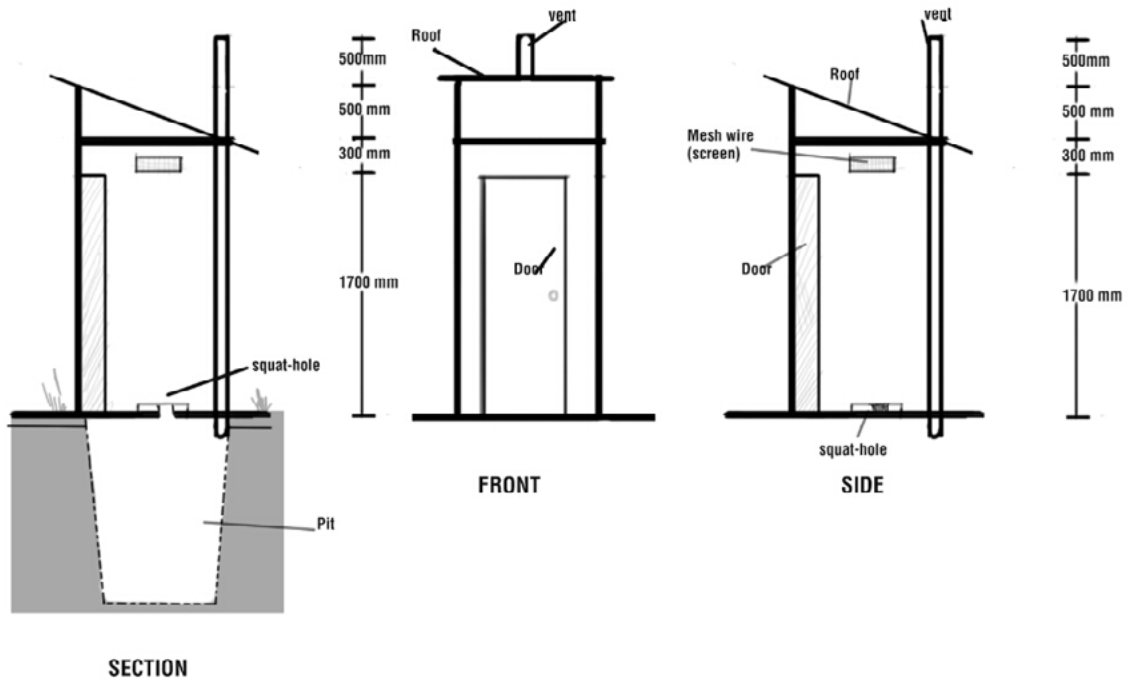

# 6

## Construction of Latrine for Pastoral Communities

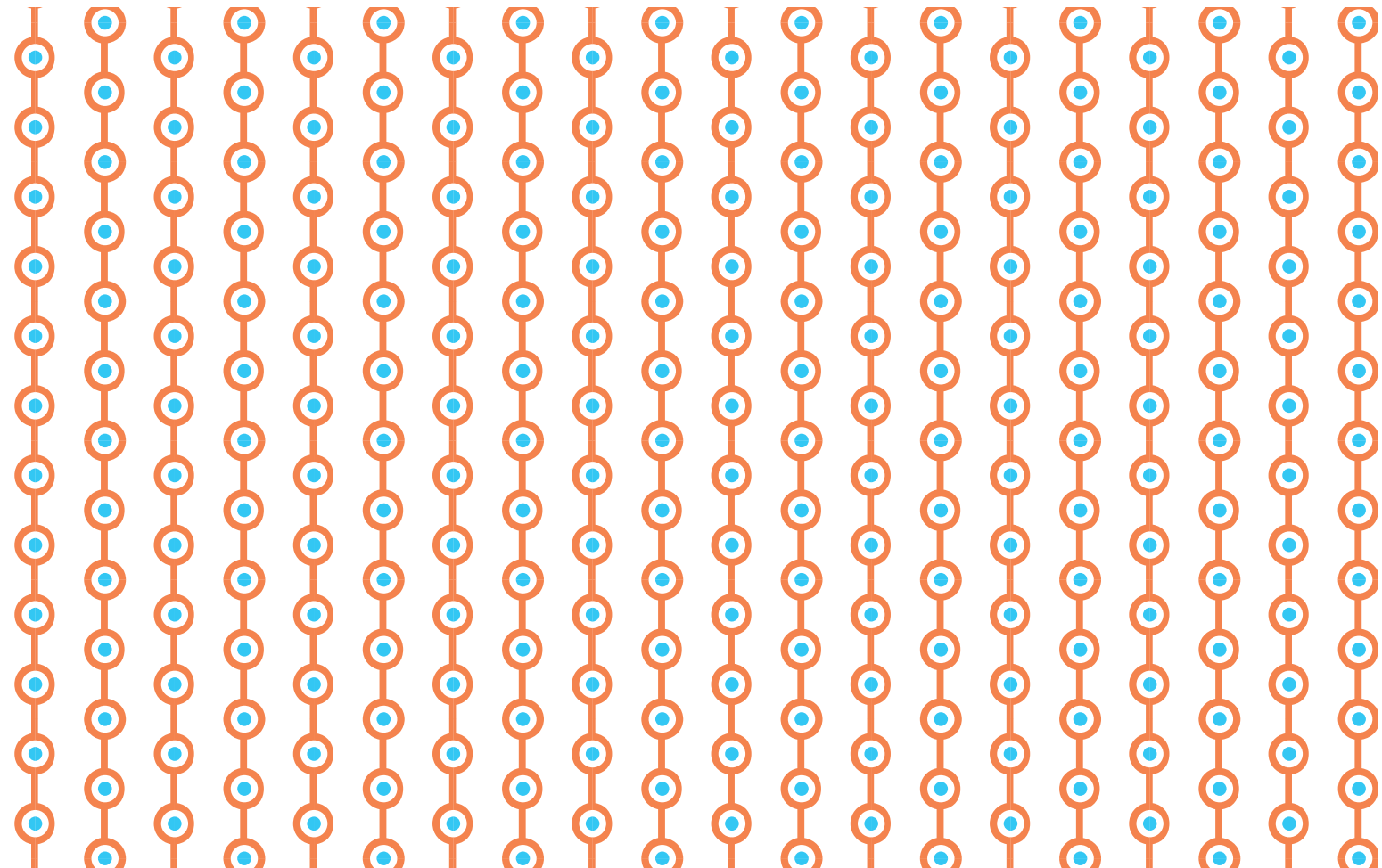

Pastoral communities in Ethiopia seasonally move from usual place of residence to commonly known places for searching of pasture and water for their cattle or herds. Usually, all family members do not move. While some of the family members remain in their home village others move with cattle herds to most commonly known places for three to six months and go back to their usual villages when rain performance improves. Even though each family member constructs small temporary shelter for dwelling, they construct a cluster of small house which is similar to camp. These communities need two types of latrine options (permanent like that of agrarian/sedentary communities) and temporary type that serve for a group of households (from the same clan) for the time period they are away from their village.

Members of the household usually move with materials for construction of temporary house (mainly materials for walling and roofing) to the places where they can get water and pasture for their cattle (herds). Right after they reach the usual places, they start to build the temporary shelter. The temporary places where they stay for three to six months are marshy areas where the ground water table is shallow or around the big river banks.

### **Construction of temporary household Latrine for pastoral communities**

Latrine construction is important for both family members who are remaining at home and those temporarily moving to other places. Household members moving with their cattle also carry materials for construction of temporary latrine to the other places. These materials may include; plastic slab with squat-hole cover, wooden frame and plastic sheet (polyethylene) for superstructure (wall and roofing) and old barrel (plastic or metal) to the

#### **6.1 For family members remaining at home village,**

- Important considerations specified under section 2; procedures to be followed to make choice of suitable materials and construction of substructure (pit digging and lining); choice of slab types and installation of slabs; and choice materials and construction of superstructure stated under section 5 are the same as for sedentary (agrarian) households.

#### **6.2 For family members moving to other places**

- Use the same factors and procedures under section 5.2.2, to determine dry pit size for the period of three to six months for a family size of five persons.

##### *6.2.1 Construction of substructure, slab and superstructure*

- If the soil is stable; follow the same procedure for excavation, construction of slab and superstructure for households living in sedentary communities.

##### *6.2.2 Construction of substructure in places with unstable soil formation*

- Excavate the circular pit with depth of 1000mm and diameter of 1000mm (follow the same procedure under section 5.3.1 above)
- Insert old metal or fiber barrel with size of 800mm diameter and 900mm height (this size of barrel serve 5 persons for six months (family members) moving to other areas.
- Excavate a pit with size of 1000mm diameter and 1200mm depth

##### *6.2.3 Installation of plastic slab*

- Follow the same procedures stated under section 5.6.2 above for installation of plastic slab

**Figure 43:** Temporary latrine pit lined with old barrel

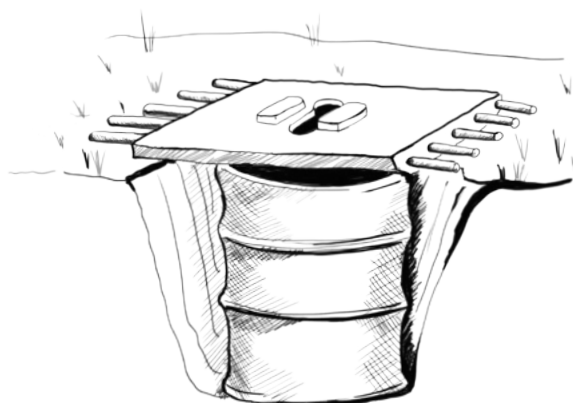

**Temporary latrine pit lined with old barrel**

#### 6.2.5 Construction of Superstructure

- Construct moveable superstructure using the same materials used for construction of the temporary house (follow the same procedure stated under section 5.7.3 above)

#### **Abandoning the temporary latrine**

- Remove materials for construction of superstructure and the slab, disinfect with chlorine solution (bleach), bind the same as materials for temporary house and take it back home
- Cover the pit with soil before moving back to usual place of residence
- If the moving family member goes back to the same place next year, excavate new pit, construct and use temporary latrine, and demolish when return to usual residence following the same procedures as stated above

# 7

## Soil Type and Choice of **Suitable Materials for Construction of Latrine Substructure, Slab and Superstructure**

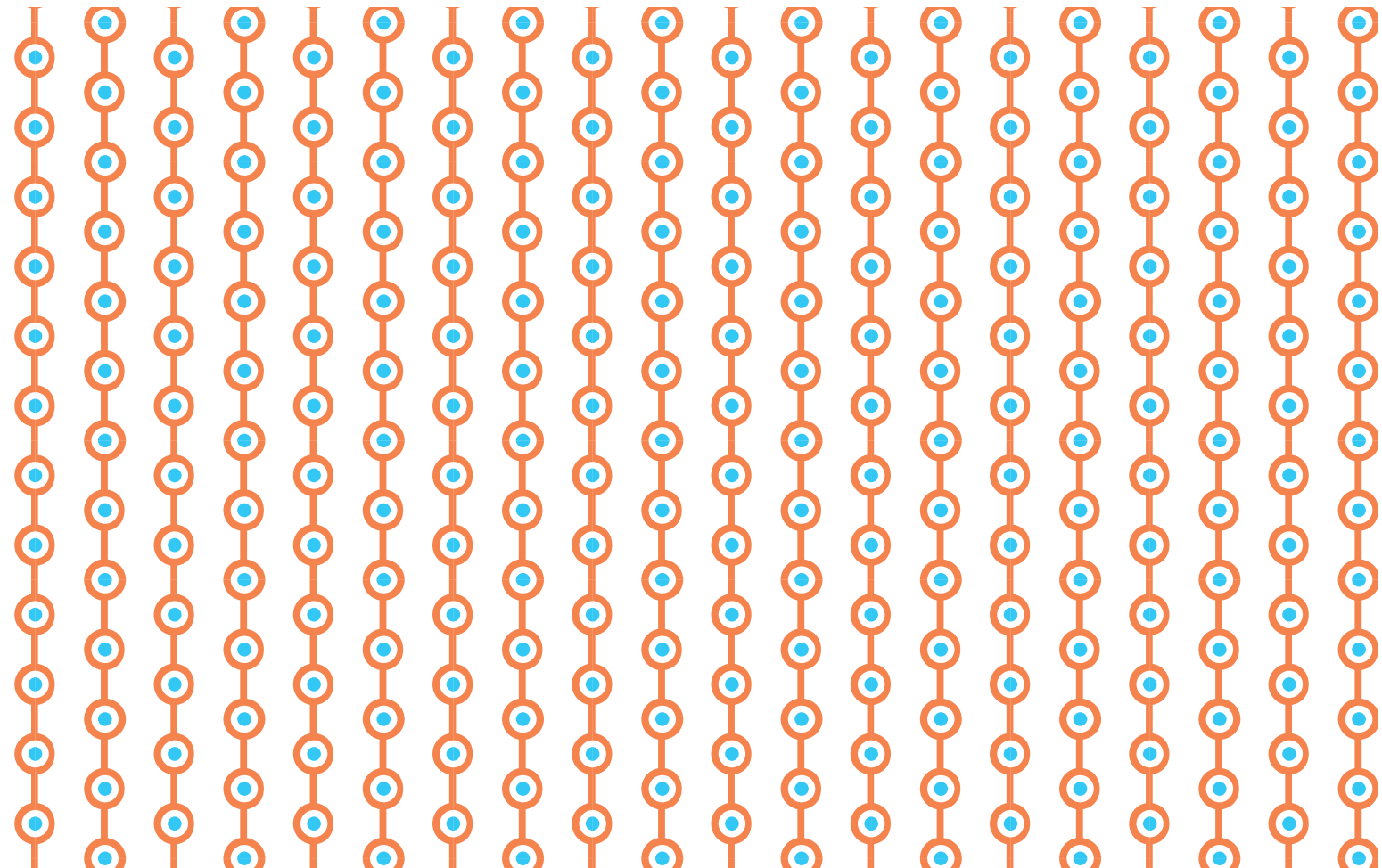





Soil type	Substructure type	Floor/slab type	Superstructure type Walling materials	Roofing materials	Type of latrine option
<b>Loose soil (silt/ clay)</b>	<ul style="list-style-type: none"> <li>- Circular, rectangular or square shape pit.</li> <li>- The whole pit depth lined with stone or bricks; or the pit depth below to 500mm lined with wood or bamboo</li> <li>- Top 500mm depth of the pit lined by durable material (stone or bricks) if depth below top 500mm is lined with wood or bamboo</li> </ul>	<ul style="list-style-type: none"> <li>- Removable SanPlat concrete slab with the same shape with the pit</li> <li>- Reinforced Concrete slab or plastic slab with the same shape with the pit and with tightly fitted squat-hole cover or with bamboo or PVC vent pipe</li> <li>- Reinforced concrete Slab split in to two or more pieces depending on the diameter /size of the pit (rejoined with mortar together during installation) for easy transportation and transfer to new latrine</li> <li>- At least 150mm overlap between slab and lining material on all sides</li> <li>- Ceramic or plastic pan with water seal fitted in to the slab</li> </ul>	Removable Wall that provide adequate privacy made up of bricks or stone (built off the slab), wood, bamboo, Corrugated Iron Sheet (CIS), grass, or plastic sheet supported by wooden pole (fitted on the slab)	Removable Roof that prevent user from direct sun heat and rain (not leaking), made from CIS, Grass, plastic sheet or leaves supported by wooden poles	<ul style="list-style-type: none"> <li>- Ventilated Improved Pit Latrine (VIP)</li> <li>- Double vault Compost latrine</li> <li>- Pour flush latrine (onsite or off-site)</li> </ul>
	<ul style="list-style-type: none"> <li>- Circular, rectangular or square shape pit.</li> <li>- The whole pit depth below top 500mm lined with wood or bamboo</li> <li>- Top 500mm depth of the pit lined with precast reinforced concrete ring</li> <li>- Top 500mm depth of the pit lined with precast reinforced blinded concrete ring and around the concrete ring mounded/ compacted by durable material and mortar</li> </ul>	<ul style="list-style-type: none"> <li>- Removable SanPlat concrete slab with the same shape with the concrete ring</li> <li>- Removable Reinforced Concrete slab or plastic slab with the same shape with the concrete ring and with tightly fitted squat-hole cover or with bamboo or PVC vent pipe</li> <li>- The reinforced concrete Slab can be split in to two or more pieces depending on the diameter /size of the concrete ring (rejoined with mortar together during installation) for easy transportation and transfer to new latrine</li> <li>- Slab should fully overlap with the thickness of the concrete ring (lining material) on all sides</li> <li>- Ceramic or plastic pan with water seal fitted in to the slab</li> </ul>	Removable Wall that provide adequate privacy made up of wood, bamboo, Corrugated Iron Sheet (CIS), grass, or plastic sheet supported by wooden pole (wall fitted on or off the slab)	Removable Roof that prevent user from direct sun heat and rain (not leaking), made from CIS, Grass, plastic sheet or leaves	<ul style="list-style-type: none"> <li>- Ventilated Improved Pit Latrine (VIP)</li> <li>- Double vault Compost latrine</li> <li>- On site or off-site Pour flush latrine</li> </ul>
<b>Loose soil (sandy)</b>	<ul style="list-style-type: none"> <li>- Circular, rectangular or square shape pit.</li> <li>- The whole pit depth below top 500mm lined with wood or bamboo</li> <li>- Top 500mm depth of the pit lined with precast reinforced concrete ring</li> <li>- Top 500mm depth of the pit lined with precast reinforced blinded concrete ring and around the concrete ring mounded/ compacted by durable material and mortar</li> </ul>	<ul style="list-style-type: none"> <li>- Removable SanPlat concrete slab with the same shape with the concrete ring</li> <li>- Removable Reinforced Concrete slab or plastic slab with the same shape with the concrete ring and with tightly fitted squat-hole cover or with bamboo or PVC vent pipe</li> <li>- The reinforced concrete Slab can be split in to two or more pieces depending on the diameter /size of the concrete ring (rejoined with mortar together during installation) for easy transportation and transfer to new latrine</li> <li>- Slab should fully overlap with the thickness of the concrete ring (lining material) on all sides</li> <li>- Ceramic or plastic pan with water seal fitted in to the slab</li> </ul>	Removable Wall that provide adequate privacy made up of wood, bamboo, Corrugated Iron Sheet (CIS), grass, or plastic sheet supported by wooden pole (wall fitted on or off the slab)	Removable Roof that prevent user from direct sun heat and rain (not leaking), made from CIS, Grass, plastic sheet or leaves	<ul style="list-style-type: none"> <li>- Ventilated Improved Pit Latrine (VIP)</li> <li>- Double vault Compost latrine</li> <li>- On site or off-site Pour flush latrine</li> </ul>

Soil type	Substructure type	Floor/slab type	Superstructure type Walling materials	Roofing materials	Type of latrine option	
<b>Water logged (marshy)</b>	- The whole pit depth lined water tight with precast reinforced blinded concrete ring (water tight)	- Removable SanPlat concrete slab with the same shape with the concrete ring	- Removable Wall that provide adequate privacy made up of wood, bamboo, Corrugated Iron Sheet (CIS), grass, or plastic sheet supported by wooden pole (wall fitted on or off the slab)	- Removable Roof that prevent user from direct sun heat and rain (not leaking), made from CIS, Grass, plastic sheet or leaves	- Ventilated	
	- Bottom of the pit made from water tight concrete bedding	- Removable Reinforced Concrete slab or plastic slab with the same shape with the concrete ring and with tightly fitted squat-hole cover or with bamboo or PVC vent pipe			- Improved Pit Latrine (VIP)	
	- Depending on the height of water logging above the ground level, concrete ring is installed above the ground.	- The reinforced concrete Slab can be split in to two or more pieces depending on the diameter /size of the concrete ring (rejoined with mortar together during installation) for easy transportation and transfer to new latrine				- On-site Pour flush latrine
	- Space around the concrete ring above the ground level is mounded/compacted by selected soil materials	- Slab should fully overlap with the thickness of the concrete ring (lining material) on all sides				
		- Ceramic or plastic pan with water seal fitted in to the slab				

# 8

## Operation and Maintenance of the Household Latrines

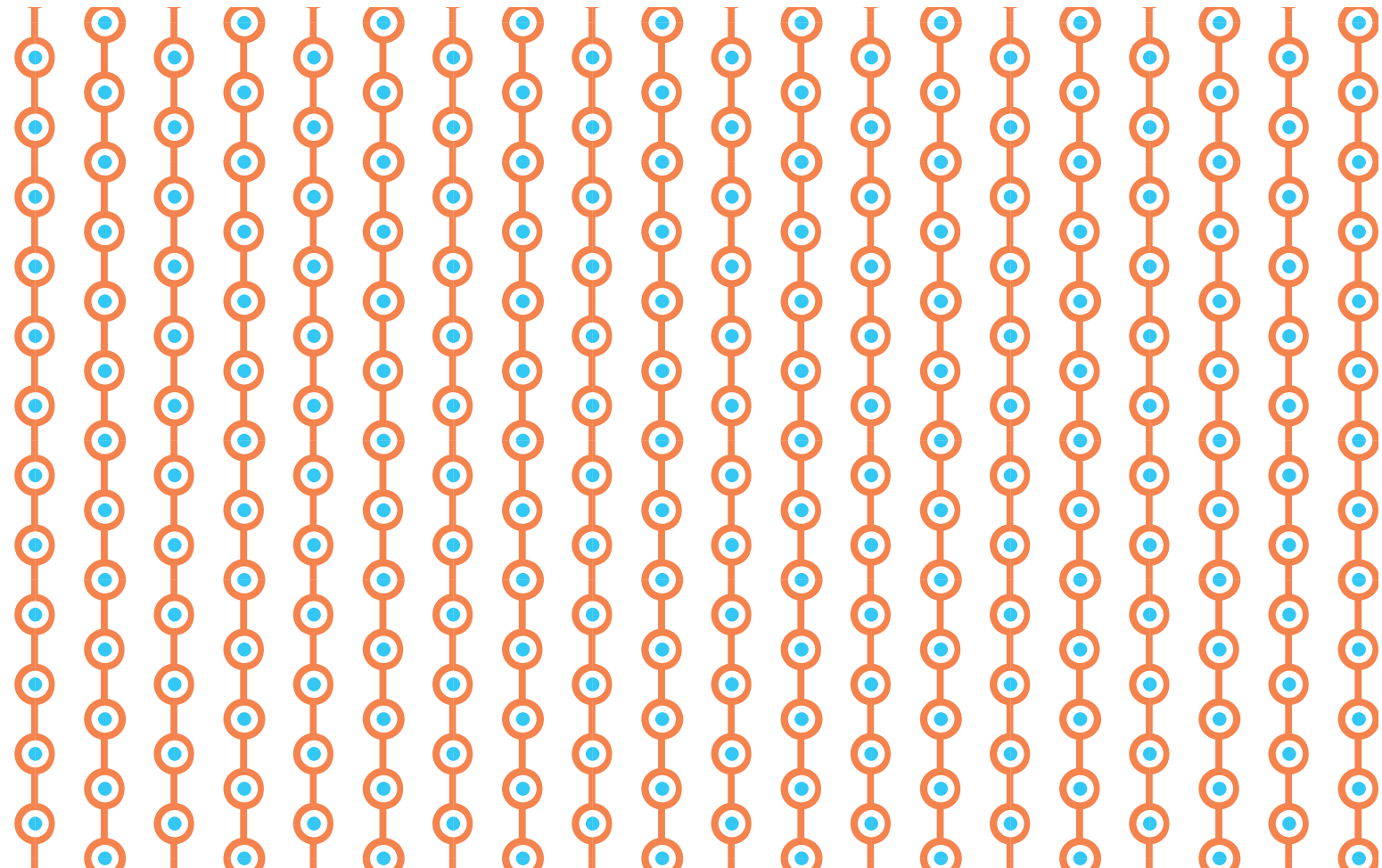

### 8.1. Routine Operation and Maintenance

Routine and periodic operation and maintenance is intended to keep a toilet functional and keep in a condition that makes family members comfortable to consistently use it. Poor operation and maintenance of latrines is identified to be key constraints for the consistent and continuous use of sanitation facilities by the households.

This section outlines maintenance procedures and activities for operation and maintenance of household latrines that are common to all technology options and specific to particular type of latrine technology options so as to always keep cleanliness of latrines. Table 15 provides details on operation, maintenance and repair activities common to all types of latrines and specific to each type.

**Table 15:** Operation, maintenance, and repair activities common to all type of latrines and specific to each latrine type

Type of latrine facility	Operation and maintenance activities	Repair and Maintenance activities
Common for all types of latrines	<ul style="list-style-type: none"> <li>- Use, day to day operation and maintenance</li> <li>- Urinate or defecate directly in to the squat-hole to avoid smearing of faeces and splash of urine on the slab (avoid unsightly bad smell)</li> <li>- Cover faeces after each defecation to discourage access to flies and to avoid bad smell</li> <li>- Regular cleaning and washing of slab to remove any faeces and urine</li> <li>- Clean the slab and edge of squat-hole immediately after use to prevent bad smell and unsightly and discourage flies</li> <li>- Replace squat-hole cover after each latrine use</li> <li>- Place appropriate anal cleansing material (water, paper, soft paper, or leaf) inside the latrine and dispose it in to the pit after use.</li> <li>- Do not use non-decomposable materials like stone, plastics, rags should not be used for anal cleansing – to prevent latrine clogging</li> <li>- Scoop feces of the small children and dispose in the latrine</li> <li>- Do not dispose soiled sanitary pads in to the latrine pit (burn and dispose together with solid wastes)</li> <li>- Properly Wash your hands and (hands of your children) with soap and water after each latrine use</li> <li>- Continuous community awareness creation, education and communication on latrine use operation and maintenance of each latrine option and importance, health and safety of using the compost produced from human feces</li> </ul>	<ul style="list-style-type: none"> <li>- Check for any cracking on the slab, damage of the wall and door, roofing, flood diversion ditch and make repair or maintenance and take immediate repair/maintenance action any observed problem.</li> <li>- Check for if the pit is full and dig new pit before when the pit remains with 750mm to fill. Transfer the slab and superstructure to new latrine.</li> <li>- Cover and seal the old latrine content (sludge) with soil (at the top 500mm)</li> <li>- If pit lining is constructed from durable materials (Stone, bricks or concrete ring) manually excavate the pit content (compost) after 2 years and make ready for re-use when the second latrine becomes full and sealed</li> <li>- Use personal protection devices while emptying and taking care to avoid poisoning</li> <li>- Check for cracks on the slab and repair</li> </ul>

Type of latrine facility	Operation and maintenance activities	Repair and Maintenance activities
<b>Specific to Ventilated improved pit latrine (VIP latrine)</b>	<ul style="list-style-type: none"> <li>- Do not cover squat hole should to allow air entrance</li> <li>- Keep inside of the superstructure dark by closing the door and roof well covered to discourage flies coming out through squat hole</li> </ul>	<ul style="list-style-type: none"> <li>- Check for damage of the fly screen and odor coming through the squat-hole</li> </ul>
<b>Specific to Compost latrine (double vault dry compost and Arborloo latrine)</b>	<ul style="list-style-type: none"> <li>- After each use, cover the faeces with ash or saw dust or leaves to soak up excessive moisture, and improve carbon-nitrogen ratio.</li> <li>- When the first is about 75% full, fill completely with dry powdered earth material and seal.</li> </ul>	<ul style="list-style-type: none"> <li>- Transfer the slab, and superstructure to the second vault and continue to use the second vault</li> <li>- Close the vault for at least two years to facilitate anaerobic decomposition and killing of disease pathogens, and then manually empty the decomposed pit content and use for fertilizer</li> <li>- Use personal protection devices when you excavate compost to prevent contamination, poisoning by Ammonia, methane and hydrogen sulfide gases, and cut by broken sharp metals or glasses</li> </ul>
<b>Specific to Arborloo latrine</b>	<ul style="list-style-type: none"> <li>- Dig another pit of the same shape and dimension before pit become 75% full</li> </ul>	<ul style="list-style-type: none"> <li>- Transfer the slab, and superstructure to the second pit and use the latrine</li> <li>- Close the pit for at least two years and plant fruits and vegetables. If fruits/vegetables planted in the pit with fresh excreta, pathogens (bacteria, protozoan and worm eggs) remain infectious particularly in humid areas</li> </ul>
<b>Pour flash latrine (onset or offset)</b>	<ul style="list-style-type: none"> <li>- Put the container in the latrine and fill with sufficient water and cover the container</li> <li>- Fill hand washing container and avail soap or ash to encourage hand washing after latrine use</li> <li>- Splash water after each use and sweep the slab or pan</li> <li>- Do not dispose soiled sanitary in to the latrine (it easily clogs water seal)</li> <li>- Do not use hard materials for anal cleansing</li> </ul>	<ul style="list-style-type: none"> <li>- Check for clogging of the drainage pipe and remove clogging if any</li> <li>- Check for over flow and level of sludge in the collect ion pit</li> <li>- Close sewage flow when the pit in use is full to 50 cm depth and divert the flow to next chamber/pit</li> </ul>

## 8.2 Pit Emptying

On-site dry pit latrines are common household sanitation facility in rural and small towns in Ethiopia. Properly constructed and well-managed pit latrines contain faecal sludge and can provide a safe and adequate barrier to the spread of pathogens. Faecal sludge in dry pit latrine is usually is dry and thicker solid materials, and can only manually removed with spade. Therefore, manual emptying of pit latrine is the only option.

In majority of rural areas, space is not an issue and households can dig new latrines when the old pit becomes full move the slab and superstructure, and install on a new pit. The old pit should be covered with earth for at least two years, to allow the pit content (fecal sludge) to be fully treated through the process of decomposition and become safe to handle. Then the pit can be emptied and the content can be used as soil conditioner and then re-use the pit.

In cases, Where space is in a short supply (densely populated areas) or where the cost of constructing new latrine (excavation and lining with durable material) or double vault latrine (twin pits) is viewed to be prohibitive pit latrine will need to be emptied prior to the sludge being safe. Emptying of the fecal sludge should be carried out with care to prevent risk of hazardous waste coming into contact with humans and the environment.

Where appropriate and necessary, the design and construction of the pit latrine should allow for the emptying of the contents of pits. For example, a latrine pit lined with locally available durable materials, such as bricks, stone or reinforced concrete ring, makes emptying easier compared to unlined pit. Pit lined with durable materials a less likely to collapse during emptying and pose less danger to the emptier.

Emptying excreta from a pit is an unpleasant task and can be extremely hazardous, both from a public health point of view and a safety perspective. Ideally the pit should be emptied by people standing at ground level and using shovels, buckets and ropes to remove the excreta, without having to enter into the pit. In reality, this is rarely the case, as the excreta can be quite dense and difficult to shift and many pits are too deep to remove the excreta without entering them.

### Steps of pit emptying

- Gloves, boots and other personal protective equipment is essential, as are washing facilities close to the pit.
- At least part of the pit cover slab will need to be removed to provide access and improve air circulation.
- The pit should be left to “vent” for some time before anyone enters it and fans can be used to improve the circulation of air in the pit.
- Excavate new pit when the old pit became to fill to the depth of 1000mm (1m) and line pit with durable material (follow the same step stated under section 5.3.1 and 5.3,2 above)
- When the old pit become to fill up 50cm depth, move the slab and superstructure and install on the new pit.
- If the latrine is compost latrine with twin pit, cover the pit when pit fill to 50cm depth, move the slab and superstructure and install on the new pit.
- Buckets will be needed to lift the contents to the surface.
- Immediately cover faecal sludge in the old pit or alternate pit (vault) with earthen material and keep closed for about two years
- When the second pit or the vault in use is about to fill to the top depth of 1000mm (1m),

manually empty the treated (decomposed) contents of the previous pit (vault) and make the pit ready for reuse.

- Manual emptying can take several days, depending on the size of the pit and the consistency of the contents



### Think Safety!

No one should enter a pit without wearing a harness and safety rope. The rope should be held by at least 2 people standing on the surface, who can lift the person out of the pit if overcome by fumes, or the pit starts to collapse. Pit walls, especially in unlined pits, can collapse if the pit is emptied after years of being filled. The structural stability of the pit walls must be continually monitored as emptying takes place.

## Disposing of fecal sludge

Once fecal sludge has been removed from the pit, it needs to be transported and disposed of carefully. There are several options – some of which are mentioned here.

### 1. Direct burying

Smaller volumes of sludge can be buried directly in a trench. The sludge is placed in layers (e.g. 100 mm thick) that are then covered with 200 mm of soil before the next layer of sludge is added. The final layer should always be soil. After a couple of years, the contents can be dug out and used as a soil conditioner.

Crops grown in the area should not come into direct contact with the soil where fecal sludge is applied (so growing trees on the land is best and growing beans or corn is better than salad crops). The disposal site should be away from any water source and areas that are liable to flooding. As a possible route for fecal contamination is through rainfall runoff, surface water must be directed away from any disposal site, using ditches or low soil embankments

### 2. Co-composting and applying to land

Fecal sludge can be composted, mixing it first with 2-3 times its volume of vegetable waste to enhance an aerobic composting process. As has been practiced in countries including Ghana, Haiti and South Africa, the mixed compost can then be applied to farmland. As the compost is likely to contain plastic bags, stones and faeces that are not fully decomposed, it should be buried with a soil covering at least 0.5 m deep. Burying excreta in a shallow trench with a large surface area, is better than a deep pit, as a trench is easier to dig and provides better protection to any groundwater resources.

### 3. Drying beds and ponds

Large quantities of fecal sludge may require more formal treatment, for example by drying it in a sludge drying bed. This shallow basin must be sited away from houses and designed to ensure the contents cannot be washed away by rainfall.

### 4. Discharge into a sewer

If the sludge is fairly liquid and there is a sewerage system nearby, it can be emptied into a trunk sewer, or at the start of a wastewater treatment works, with the permission of the local sewage authority. Sludge should not be emptied into storm water drains unless they are so polluted already it is the best environmental option available.

# 9

## **Health and Safety Measures**

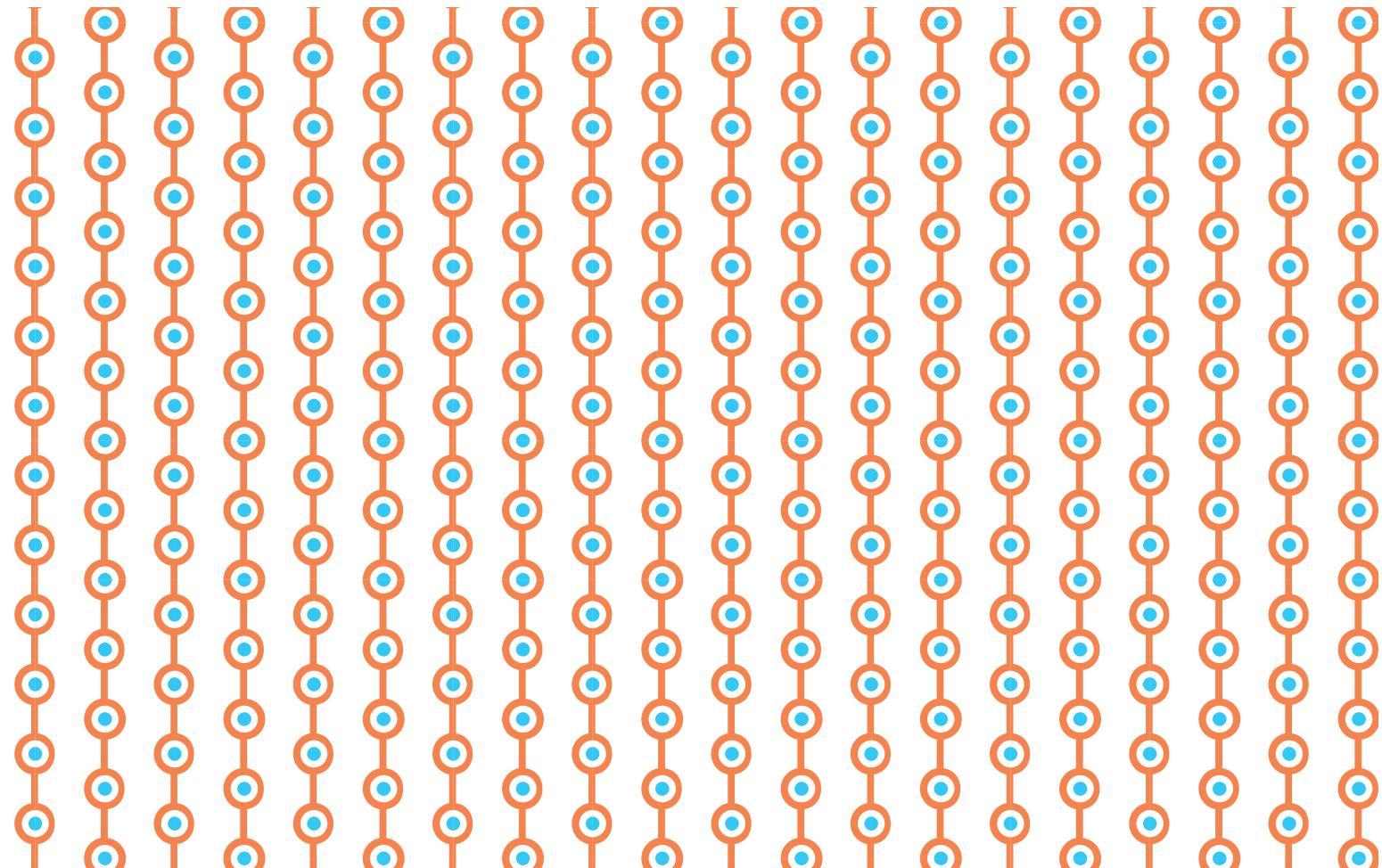



Any type of work exposes workers to different types of work related hazards and associated health problems. Any person including entrepreneurs and family members working on pit excavation, construction, operation and maintenance of the latrine may be exposed to work related accidents and result in acute injurious health problems, chronic illness, temporary or permanent disability including loss of body parts or death.

Therefore, it is important to take special precautions during different phases of construction works including during site clearing, pit excavation, lining, construction and installation of latrine slabs, construction of superstructure and finishing works and during routine operation and maintenances of the latrines. The following table (Table 13) provides information on possible occurrence of hazards and action to be taken to prevent associated health problems and important personal protective devices recommended to be used by workers engaged in construction of latrines are listed below in Table 14.

## 9.1 Safe Working Procedures and Precautions

Implementation of the Safe working processes and procedures and use of personal protective equipment have very important contribution to workers' effort to eliminate or prevent occurrence of the acute and chronic work related health hazards. Therefore, the following precautions are highlighted being guidance note for entrepreneurs and family members of the households.

### 9.1.1 Precautions During Pit Excavation, Masonry Pit Lining Works

- During site preparation, construct temporary fencing around the pit to avoid accidents (animals and children may fall in to the pit)
- Entrepreneurs, households or daily laborers can prepare stepping holes on the wall of the dug pit (to be used for getting in and out). This is possible if the soil formation is hard. In case of loose soil formation, prepare wooden or metal ladder and use while excavating and lining of pit walls.
- Check inside of the excavated pit with torch-light before entering. Dangerous animals like snake may fall in during the night, and remove such animals if it happened.
- Remove soil materials, hand tools and sharp objects away from the working space (2 meter) of the edge of the pit to avoid back falling.
- Worker (mason/carpenter) should use helmet during excavation and pit lining to prevent head injury and use eye goggle to prevent their eyes
- Do not throw the stone while mason is inside the pit, and use strong string/rope for conveying of mortar using bucket
- Use rubber gloves and safety shoes to avoid abrasion, cut and irritation during pit digging, excavation, lining works

### 9.1.2 Precaution During Concrete Slabs Production, Lifting, Transporting and Installation

Accident and permanent damage to body parts may happen during placing of moulds, cutting reinforcement bars, and mixing and pouring of the concrete, and during lifting, transporting and installation of the slabs. Therefore;

- Use rubber gloves, long sleeves and safety boots to avoid direct contact with body parts and to minimize possibility of cuts, abrasions, and burning
- Use masks and eyeglass to avoid inhalation of cement dusts and entering in to the eyes

### 9.1.3 Precaution During Routine Cleaning of Latrine and Emptying of Compost Latrines

Households are likely to come in direct contact with human excreta during day to day cleaning

of latrine and emptying of the compost latrines and consequently exposed to different disease causing microorganisms and contaminate household utensils. To avoid or minimize possible exposure, family members are expected to consistently;

- Use personal protective devices such as long sleeves, rubber gloves, rubber boots and hair caps while on daily cleaning of latrines and emptying of compost latrines.
- Keep latrine cleaning, and pit emptying equipments in a good repair and operation
- Maintain proper personal hygiene practices including bathing and hand washing daily after leaning works, wash and disinfect protective devices after each use and cleaning materials





**Table 16:** Summary of the work related hazardous exposure, health hazards and preventive measures

Hazardous exposure/event	Health hazards	Preventive/control measures
Caving-in of the pit walls in areas of loose soil formation and sliding back of excavated soil/stone, misplaced hand tools on the edge of the pit	Suffocation, fracture, death, head injury	Clean around edge of the pit, and working areas, use helmet, gloves and boots during excavation, fencing around the pit,
Sliding due to improperly built ladder and caving-in of pit walls	Cause abrasion, strain, sprain and/ or fracture	Making surface rough, properly build working ladder with strong wood, early treatment seeking. During digging pit, if the soil is sandy and loose, insert concrete rings and dig inside the ring
Damage to body parts (Cut) due to falling of sharp equipment on the exposed body parts (head), improper handling and use of sharp materials, nail pricking, accident due to falling of wood, stone and construction materials during excavation and pit lining works, and slab installation	Bleeding, fracture, death	Use duty gloves and boots/shoes, helmet, over wear, etc. Remove any sliding objects from the working areas. Temporary fencing around the pit. Apply first-aid to stop bleeding, and early treatment seeking.
Damage to body parts (fracture, abrasion, cuts) of small children and animals due to falling in the open pit	Damage to body parts, death	Temporary fencing around the pit until installation of slab is completed. Apply first-aid to stop bleeding, and early treatment seeking
Poisoning by snake bite. Sometimes poisonous creatures (snake and scorpion) may fall into the pit during the night and workers may enter the pit without noticing and may be bitten.	Poisoning and death	Check inside the pit for presence of any strange things before continuing digging/ excavation and lining works
Exposure to infectious agents (pathogens) during day to day cleaning of latrines	Diarrhea and parasitic infection	Always protective equipment like heavy duty gloves and wash your hands after cleaning the latrine

### Important personal protection equipment for entrepreneurs and family members

Personal protective devices are illustrated to prevent the most frequently exposed body parts such as head, eye and face, foot, and hands from accidents.

**Table 17:** Protective Equipment

Body parts to be protected	Protective equipment	When to use	Figures of the personal protection equipment
<b>Head</b>	Plastic helmet	During pit digging and excavation, pit lining works	<p><b>Figure 45:</b> Figure of plastic helmet</p> 
<b>Eyes and faces</b>	Eye goggle	During digging/excavation, masonry work, cutting stones and cement-sand mixing, etc	<p><b>Figure 46:</b> Figure of eye goggle</p> 
<b>Feet</b>	Leather and Rubber shoes	During lifting heavy loads, excavation, masonry and concrete works and installation of concrete slabs	<p><b>Figure 47:</b> Figure of leather and rubber shoes</p> 
<b>Hands, fingers and arms</b>	Rubber or heavy duty gloves	Digging the pit, masonry and concrete work, cutting reinforcement bars, installation of slabs, daily cleaning and operation of latrines	<p><b>Figure 48:</b> Figure of heavy duty gloves</p> 

# 10

Design, Drawings and Cross-sectional view of different

## **Household Latrine Technology Options**

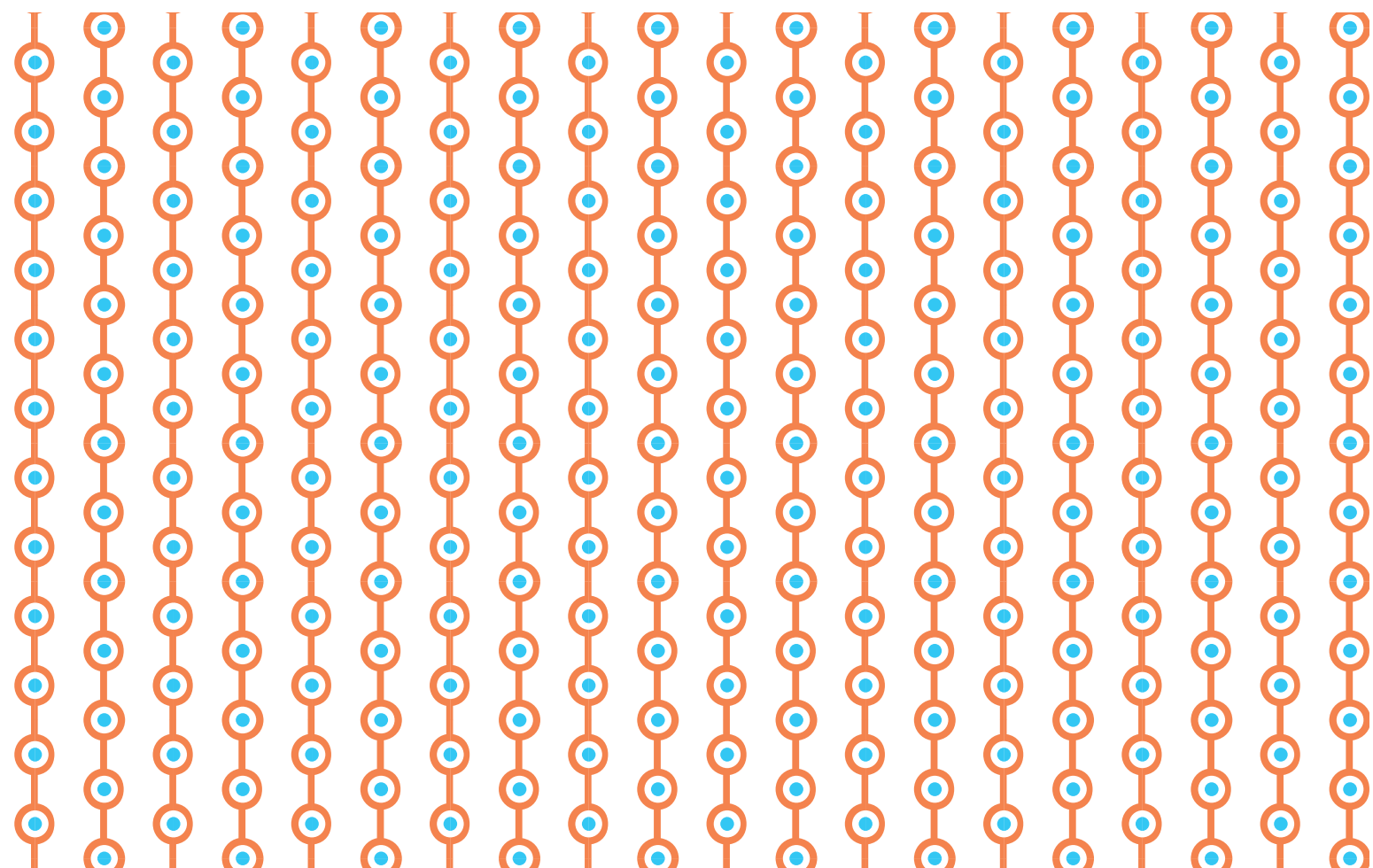

10.1 Inclusive Improved Pit Latrine (IPL) with concrete slab with squat-hole cover

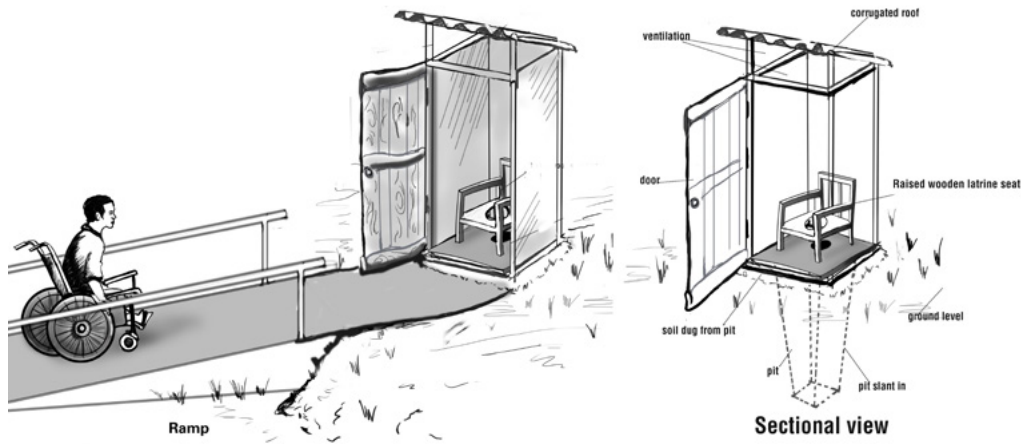

10.2 Inclusive Improved Pit Latrine (IPL) with plastic slab with squat-hole cover

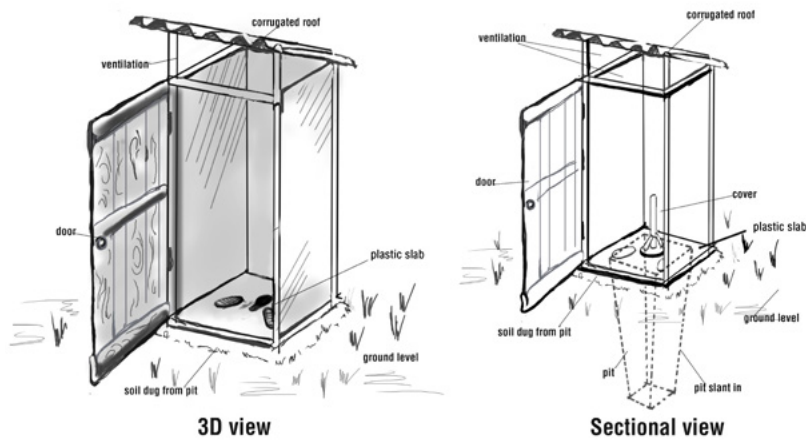

10.3 Inclusive Double vault (twin pit) compost latrine with concrete slab

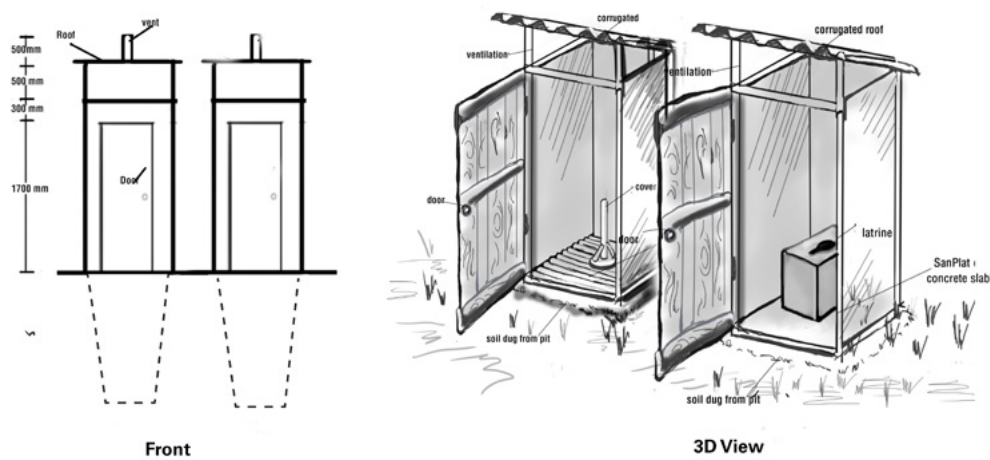

10.4 Inclusive On-site Pour flush latrine with single sock away pit

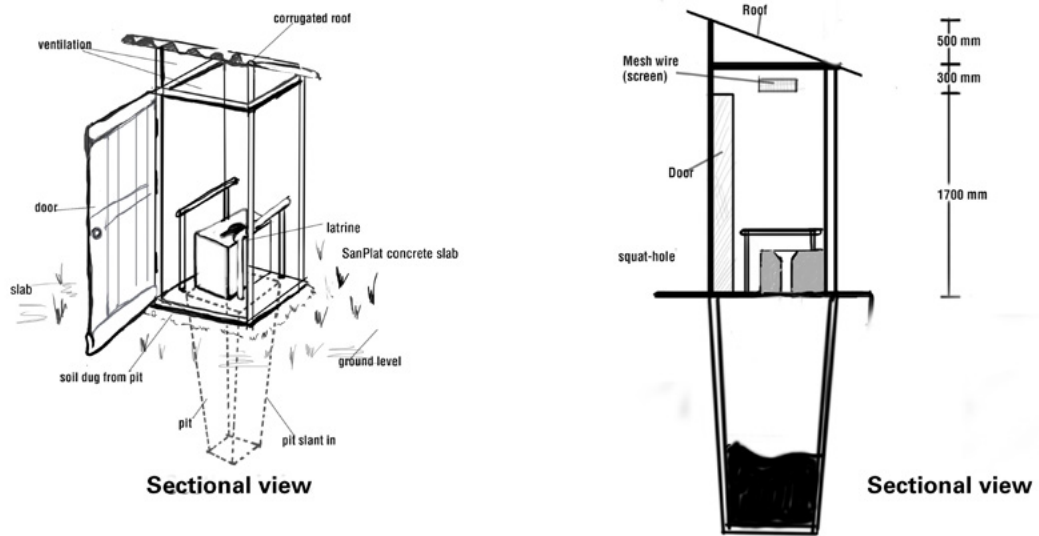

10.5 Inclusive Off-site Pour flush latrine with twin alternate sock away pit

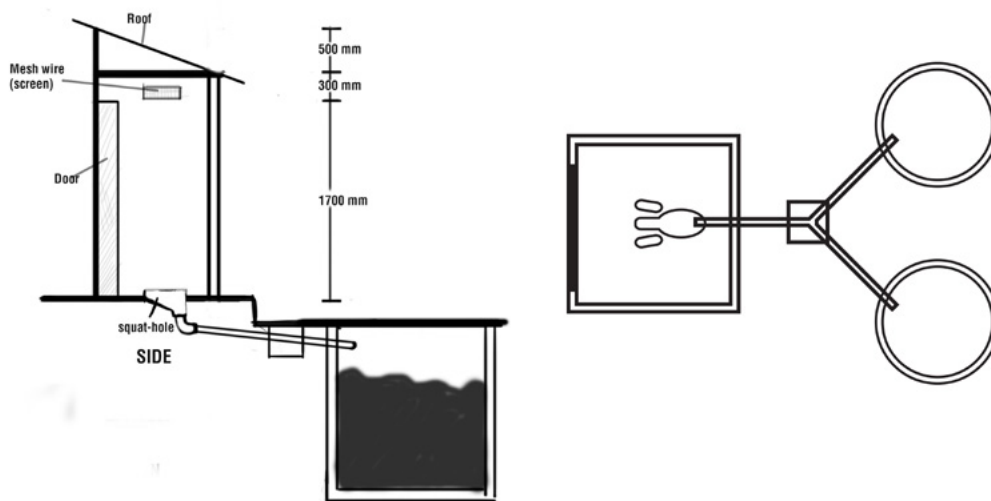

## Annexes

### Annex 1: Concrete Mortar Preparation

Mortar is a mixture of mixture of cement; sand and water which is used to stick (attach/fasten) bricks, blocks and stone together. Sticking property of the mortar depends on the quality of cement and sand. Therefore, it is important to use high grade cement and sand and clean water for mixing. Screen sand if it is mixed with silt and debris. The common ration of cement and sand is 1 part cement and 3 parts sand.

Steps for mixing concrete mortar

1. First calculate /determine amount of mortar you need
2. Measure 1 part cement and 3 parts sand using material that has the same volume (bucket)
3. First properly mix the dry components before adding water.
4. Add water slowly small by small, constantly mix until all parts are damp using trowel or shovel.
5. Apply mortar to desired area (to bricks, stone or block works) with a trowel.
6. Cure the mortared area by keeping it moist for 7 days. Cover the mortared parts of the structure with moist cloth, plastic materials, or cement bags.

### Annex 2: Conversion Factors for Quantifying Construction Materials

Construction Materials	In Kilograms	Remarks
1. 1 cubic meter of cement	350	
2. 1 meter rebar of 6mm thickness	0.222	
3. 1 meter rebar of 8mm thickness	0.395	
4. 1 meter rebar of 10mm thickness	0.62	
5. 1 meter rebar of 12mm thickness	0.89	
6. 1 meter rebar of 14mm thickness	1.21	
7. 1 meter rebar of 16mm thickness	1.56	
8. 1 meter rebar of 18mm thickness	2.0	
9. 1 meter rebar of 20mm thickness	2.47	
10. 1 meter rebar of 22mm thickness	2.98	
11. 1 meter rebar of 26mm thickness	3.85	
12. 1 meter rebar of 28mm thickness	4.83	
13. 1 meter rebar of 32mm thickness	6.31	
14. 1 meter rebar of 40mm thickness	9.80	

**Annex 3:** Summary of Household Latrine Substructure, Floor/Slab and Superstructure Construction Material Options and Estimated Costs

Substructure (lining) material Options	Estimated cost by type of lining material including excavation and labor (ETB)	Floor/Slab product/material options	Estimated cost by type of slab material including installation and labor (ETB)	Walling material options	Estimated cost by type of walling material including installation and labor(ETB)	Roofing material options	Estimated cost by type of roofing material including installation and labor (ETB)
Stone lining (3.4m depth)		Concrete SanPlat slab 600mm*600mm*80mm		Thatched /grass		Thatched /grass	
Bricks lining (3.4m depth)		Reinforced concrete slab 1000mm*1000mm*80mm		Polyethylene plastic sheet		Polyethylene plastic sheet	
Precast reinforced concrete ring of internal diameter 1000mm, thickness 100mm and height 500mm (3.4m depth)		Reinforced concrete slab 1200mm*1200mm*100mm		Woven Bamboo		Corrugated Iron sheet (CIS)	
Wood (2m depth)		Plastic Slab 700mm*700mm*50mm		Wood			
Bamboo (2m depth)		Plastic Slab 700mm*800mm*50mm		Mud block			
No lining but Top 500mm depth stone/bricks		Plastic Slab 700mm*1000mm*50mm		Bricks			
		Reinforced concrete slab 1000mm*1000mm*80mm with plastic /ceramic pan /water seal trap		Stone (mud mortar)			
				Concrete hollow block			
				Corrugated Iron sheet (CIS)			



## References

1. The Federal Democratic Republic of Ethiopia, Central Statistical Agency, Demographic and Health Survey 2011, key Indicator report, CSA, Addis Ababa, Ethiopia
2. The Federal Democratic Republic of Ethiopia Ministry of Health, Health Sector Transformation Plan (HSTP 2016-2020), Addis Ababa, Ethiopia
3. The Federal Democratic Republic of Ethiopia Ministry of Health, Latrine Technology Options, June 2010, Addis Ababa, Ethiopia
4. The Federal Democratic Republic of Ethiopia Ministry of Health, Latrine Technology Options and Construction Training manual (draft), 2013, Addis Ababa Ethiopia
5. Center for Affordable Water and Sanitation Technology (CAWST), Latrine Construction Manual, December 2014
6. Life Water International, Latrine Design and Construction Manual, Second Edition, April 2011
7. Ministry of Rural Development of Cambodia, Department of Rural Health Care, Household Latrine Construction Manual, March 2010
8. Ministry of Rural Development of Cambodia, Informed Choice Manual on Rural Household Latrine Selection, Third edition, November 2011
9. World Health Organization, A Guide to the Development of on-Site Sanitation, WHO, 1992
10. Eawag/Sandec, department of water supply and sanitation in developing countries, sanitation systems and technologies, Sandec training Tool 1.0, Module 4 , Switzerland, Eawag/Sandec, 2008
11. United Republic of Tanzania, Ministry of Health and Social Welfare, National Sanitation Option and Construction Guidelines, Dar es Salaam, March 2012
12. The World Bank, Water and Sanitation Program – East Asia and the Pacific through the Country Team Leader, Philippines Sanitation Source Book and Decision Aid, \_\_





